

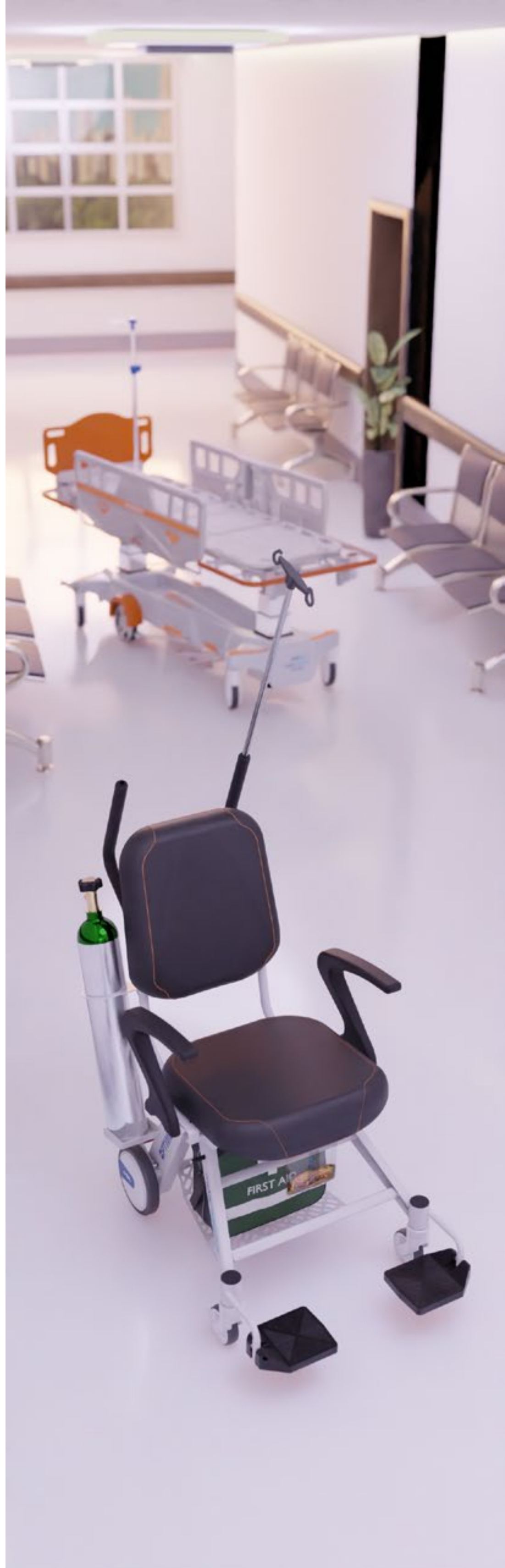

# CATÁLOGO DIGITAL



LEITOS  
MACAS  
EQUIPAMENTOS  
MÓVEIS  
HOSPITALARES

# CATÁLOGO

## CONTATO



[metahospitalar.com.br](http://metahospitalar.com.br)



+55 62 8177-2686



+55 (62) 3282-9920



@metahospitalar



@metahospitalar



[www.youtube.com/metahospitalar](http://www.youtube.com/metahospitalar)



@metahospitalar



Pq. Ind. Vice-Presidente José de Alencar  
- Avenida Elmar Arantes Cabral Qd.07 |  
Lts. 34/36, Aparecida de Goiânia - GO,  
74993-535

## CATÁLOGO DIGITAL INTERATIVO

É SÓ CLICAR E SER DIRECIONADO  
PARA A JANELA DESEJADA





# INTRODUÇÃO

Fundada em 1997, a Metahospitalar é uma companhia especializada em leitos e macas hospitalares dedicando-se à fabricação de leitos, macas, equipamentos e móveis hospitalares. Desde a fundação, já fornecemos mais de 300.000 produtos hospitalares para o Brasil e o mundo.

Temos o certificado do FDA americano para as camas hospitalares eletrônicas e macas. Além dos certificados da ISO 9001 e ISO 13485 específica de produtos para saúde.

A Metahospitalar possui registro, cadastro e autorização de

funcionamento junto à ANVISA.

Nossos produtos eletro médicos são testados e aprovados pelo INMETRO com a fundamentação científica das normas da ABNT e das engenharias aplicadas a pesquisa e desenvolvimento de produto, envolvendo a engenharia eletromecânica.





# ÍNDICE

**INTRODUÇÃO**



**SOBRE NÓS**

**MESA CIRÚRGICA | BF683 TDP**

**CAMAS CUIDADOS INTENSIVOS**

- CAMA DIAMOND TRANSVERSAL - MT 233
- CAMA DIAMOND POLTRONA - MT 231
- CAMA DIAMOND CARE - MT 215
- CAMA DIAMOND CARE - MT 212
- CAMA EVOLUTION - MT 165
- CAMA FLEX CARE - MT 155

**CAMAS CUIDADOS A LONGO PRAZO**

- DIAMOND CARE - MT 210
- EVOLUTION CARE - MT 160
- FLEX CARE SLIM - MT 153
- FLEX CARE ELETRICA - MT 152
- FLEX CARE MANIVELA - MT 149

**TRANSPORTE**

- CADEIRA PARA TRANSPORTE - MT 450
- MACA DIAMOND - MT 418 | MT 417
- MACA - MT 414 | MT 413
- MACA - MT 410

**CAMAS PPP E INFANTIL**

- PARTO LUZ NATURAL - MT 169
- PRÉ PARTO E PÓS PARTO - MT 146
- BERÇO DIAMOND KIDS - MT 304
- BERÇO DIAMOND KIDS - MT 219
- CAMA INFANTIL - MT 154

É SÓ CLICAR PARA SER DIRECIONADO A JANELA DESEJADA



## **SOFÁ**

- LIVE - MT 614
- BESTCOMFORT - MT 613
- COMPACTCOMFORT - MT 612

## **POLTRONAS**

- DADDY COMFORT - MT 643
- DADDY COMFORT - MT 644
- DADDY - MT 642
- POLTRONA SLIM - MT 641
- RECLINÁVEL MDF - MT 642
- HEMOPREMIUM - MT 639
- C.E.M - MT 636
- DIAMANTE - MT 634
- FUNCIONAL - MT 611

## **MESA DE REFEIÇÃO**

- MESA DE REFEIÇÃO DUAL - MT 725
- MESA DE REFEIÇÃO ELEVAÇÃO - MT 724
- MESA DE REFEIÇÃO INOX - MT 721
- MESA DE REFEIÇÃO - MT 717
- MESA DE REFEIÇÃO FLEX - MT 715
- MESA DE REFEIÇÃO DIAMOND - MT 714

## **MESA DE CABECEIRA**

- MESA DE CABECEIRA - MT 709
- MESA DE CABECEIRA - MT 712
- MESA DE CABECEIRA - MT 713

## **ACESSÓRIOS**

- ESTATIVA DE TETO - MT 984
- ESTATIVA MÓVEL - MT 991
- CARRO EMERGÊNCIA - MT 992
- CARRO BEIRA LEITO - MT 993
- CARRO ANESTESIA - MT 995
- CARRO DE CHECAGEM - MT 996

É SÓ CLICAR PARA SER DIRECIONADO A JANELA DESEJADA

- SUPORTE DE SORO - MT 931 | MT 933
- COLCHÃO - MT 672 | MT 660 | MT 666

## **CME**

- ESTAÇÃO DE TRABALHO - MT 500
- BANCADA DE TRABALHO - MT 501
- CARRO DE TRANSPORTE SUJO - MT 510
- CARRO DE TRANSPORTE LIMPO - MT 511
- CARRO ABERTO DE TRANSPORTE - MT 512
- SUPORTE PARA SMS - MT 513
- CARRO CUBA - MT 514
- ESTANTE PARA CESTAS - MT 520
- ESTANTE PARA ARMAZENAGEM - MT 521

## **CORPORATIVO**

- CADEIRAS GIRATÓRIAS - MT 820 | MT 821
- CADEIRA GIRATÓRIA ALLES - MT 822
- CADEIRA UP - MT 810 | MT 811 | MT 812
- CADEIRAS CONNECT - MT 813 | MT 814
- LONGARINAS - MT 815 | MT 816 | MT 817
- CADEIRA BIT - MT 818
- BANQUETA BIT BAR - MT 819
- POLTRONA RECEPÇÃO - MT 834
- SOFÁ RECEPÇÃO - MT 835
- BISTRÔS - MT 840 - MT 844
- MESA DE TRABALHO - MT 845

## **SISTEMAS E SOFTWARES**

- BEDMONITOR
- CYBERBED

# **CATÁLOGO NICOVIDA**



Ao longo de seus 27 anos, a Metahospitalar conquistou liderança no mercado de equipamentos médicos hospitalares no Brasil e no mundo.

Em 2016 decidimos internacionalizar a marca quebrando as fronteiras e paradigmas. Colocamos em prática o planejamento estratégico de exportação.

Hoje exportamos para os países da América do Sul, América do Norte e para o Continente Africano. Dentre eles: Argentina, Chile, Paraguai, Uruguai, Venezuela, Estados Unidos, República do Congo e Ghana.

No ano de 2020 a 2021 a Metahospitalar teve um salto produtivo e recorde com mais de 8.000 camas hospitalares para unidades de terapia intensiva e 38.000 produtos hospitalares.

Com suporte de assistência técnica integral a todos os profissionais da saúde. Garantindo o funcionamento de 100% de todos os leitos assim como também os demais equipamentos de nossa fabricação.

# SOBRE NÓS



Dorso bipartido elétrico com renal e inversão de pernas.

Controle remoto com cabo e controle remoto integrado à coluna, permitindo ajustes precisos durante o procedimento.

Tampo Radiotransparente em Fenolite

420Kg



### RECURSOS PADRÕES

- Chasis em Perfil de Aço Inox AISI 304.
- Predominância de movimentos motorizados.
- Base Retangular em Inox AISI 304
- Design Ergonômico e Funcional.
- Dorso bipartido elétrico com renal e inversão de pernas.
- Tampo Radiotransparente em Fenolite.
- Controle Remoto Integrado.
- Rodas Retráteis de 5 Polegadas.

- Acessórios Padrões Inclusos: 1 par de suportes de braços padrão em PU com suporte em inox, 1 arco de narcose com suporte em inox, 1 par de ombreiras e 1 jogo de colchonetes injetados em PU.
- Carga de Trabalho Segura.



Movimentos Elétricos



Acessórios



**MOVIMENTOS DO LEITO**

■ **ELEVAÇÃO** | Elevation | Elevación

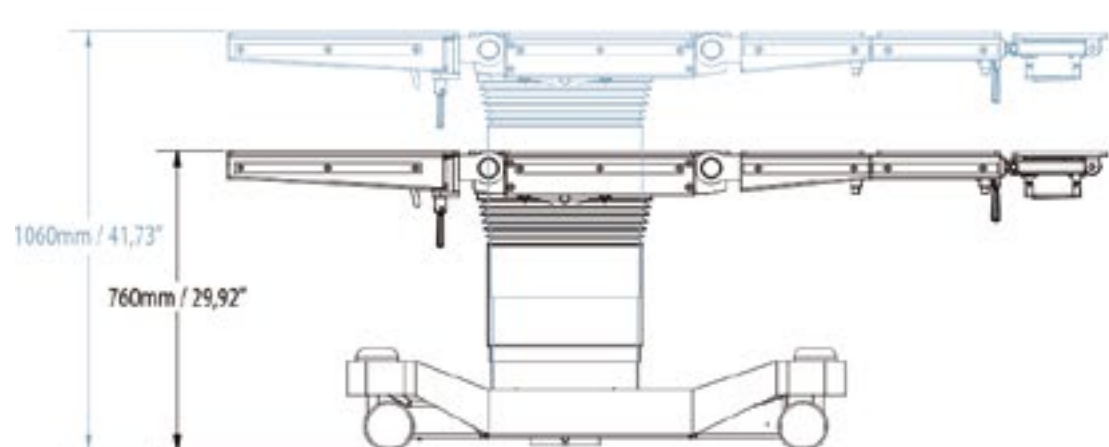

■ **DESLOCAMENTO LONGITUDINAL**  
Longitudinal movement | Desplazamiento longitudinal

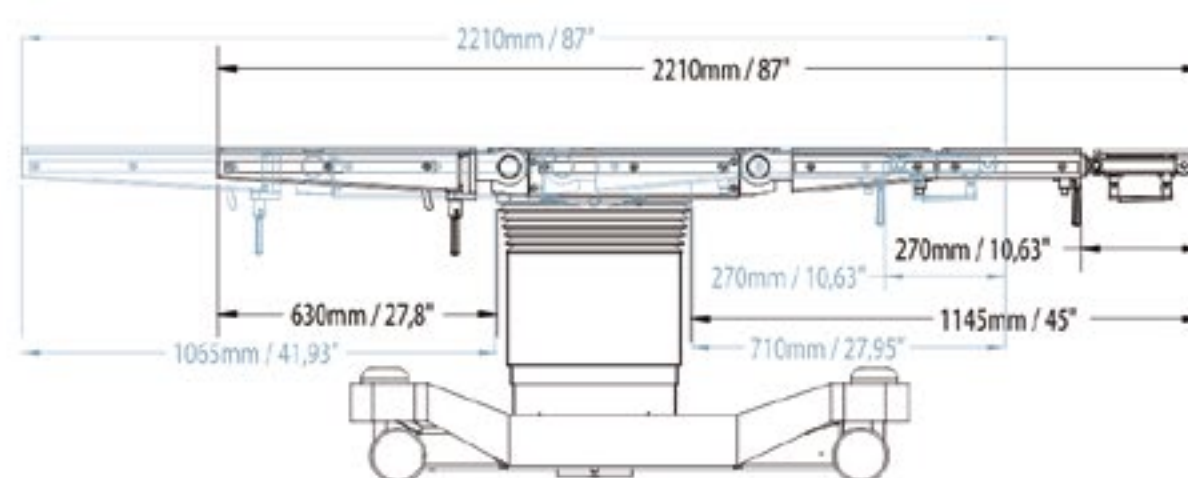

■ **TRENDELEMBURG E REVERSO**  
Trendelenburg and reverse | Trendelenburg y reverso

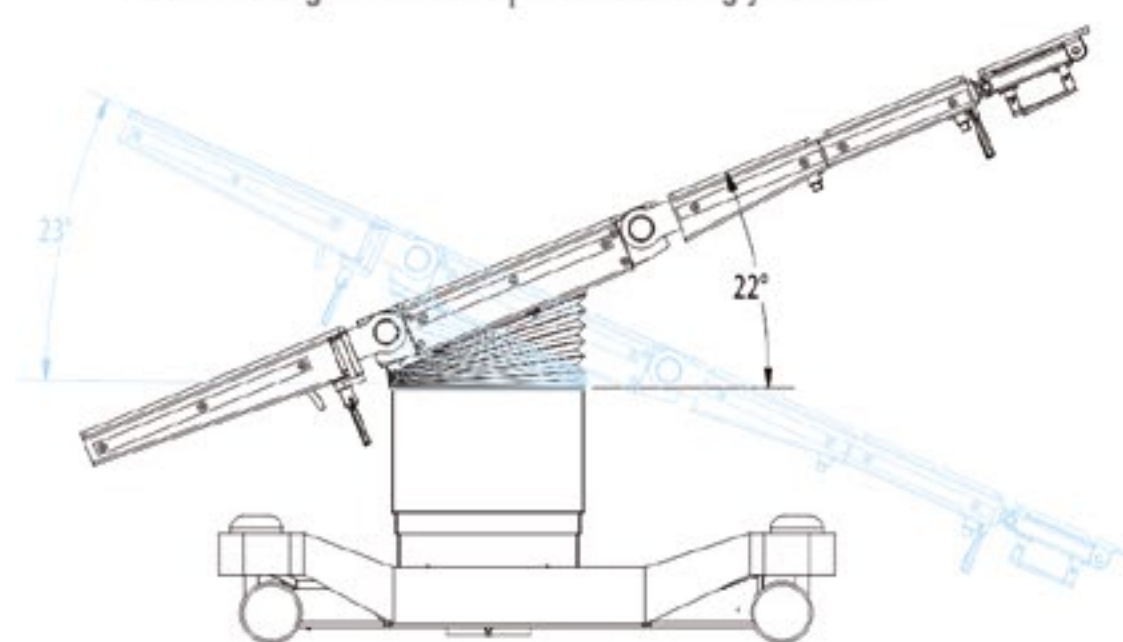

■ **LATERAIS** | Sides | Laterales

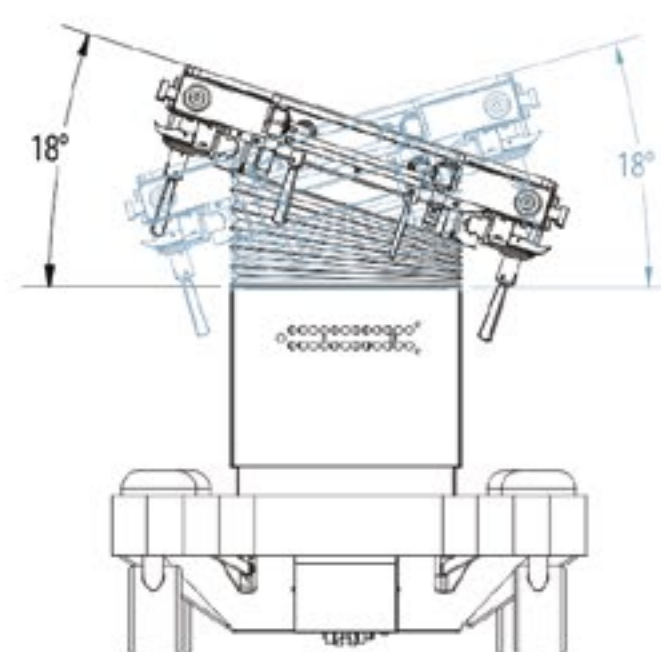

■ **\*FLEX** | Flex | Flex  
■ **\*REFLEX** | Reflex | Reflex

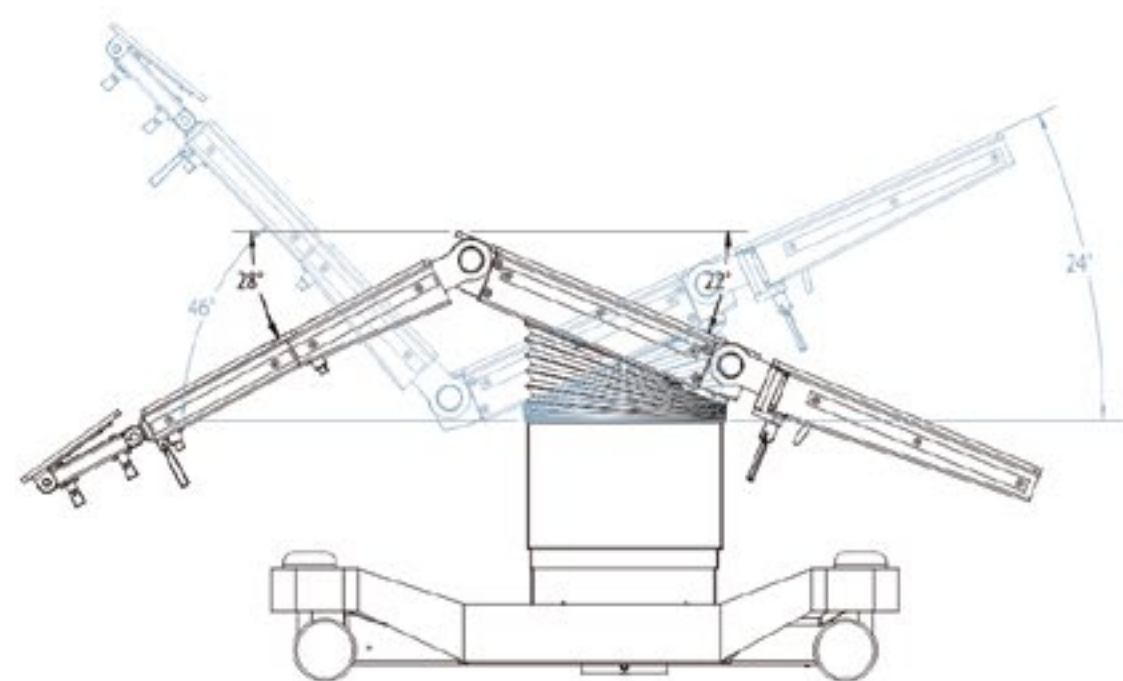

■ **\*DORSO, CABECEIRA E PERNAS**  
Back, head and legs support | Espalda, cabecera y piernas

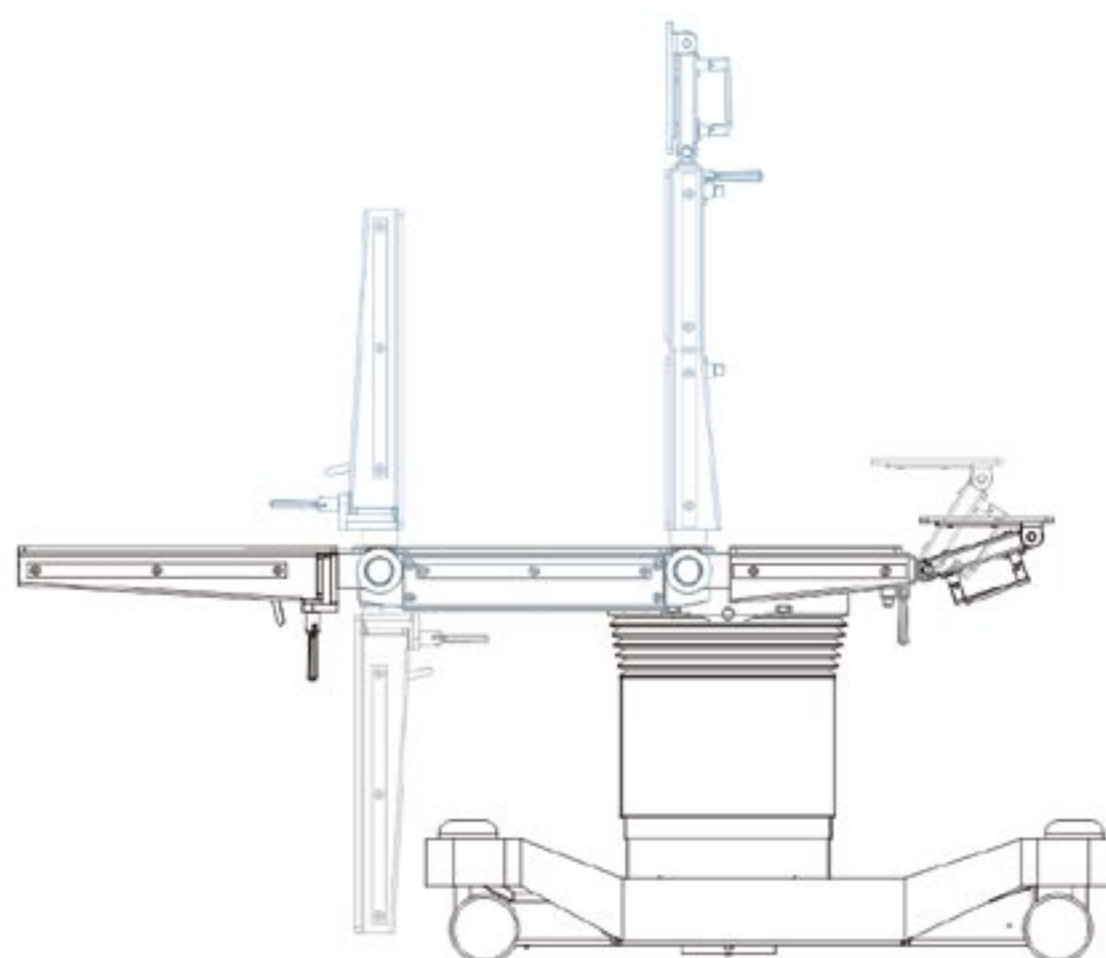

Dorso	Cabeceira	Pernas	Pernas abertura	Longitudinal	Lateral	Trend	Proclive	Elevação mínima	Elevação máxima
+ 90° - 35°	+ 90° - 90°	+ 35° - 90°	90°	340mm	- 20   + 20°	- 30°	+ 25°	700mm	1000mm



**DADOS TÉCNICOS**

Leito: Comp: 2210mm;  
Altura: 700 - 1000mm.



CAMAS CUIDADOS

# INTENSIVOS

## Toda linha de UTI possui:



CPR One touch



Grades com trava



Bumper

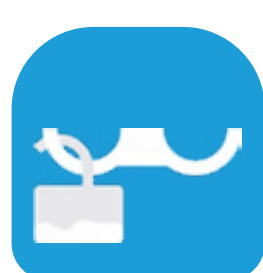

Sup. p/ bolsa de líquidos



Movimentos Motorizados



Compensação Abdominal



Suporte p/ Soro

## Lista de Opcionais:

### Touch Screen

ACO 75 - Peseira  
ACO 76 - Grade



### Colchão

MT 660 - Colméia  
MT 666 - Viscoelástico



### Sistema Bluetooth

ACO 77 - Som em uma Grade



### Conjunto de Grades

ACO 50 - Rota de Fuga  
ACO 51 - Proteção Total



### Led - Cromoterapia

ACO 37 - Peseira  
ACO 35 - Grade Rota de Fuga  
ACO 36 - Grade Proteção Total



### Porta Objetos

ACO 39\*\*\*



### Sensores I

ACO 80 - Freio  
ACO 81 - Saída Parcial



### Tábua de massagem cardíaca

MT 718



### Sensores II

ACO 83 - Grade Abaixada  
ACO 82 - Altura\*\*



### Mesa de refeição

MT 714



### Quinta Roda

ACO 33

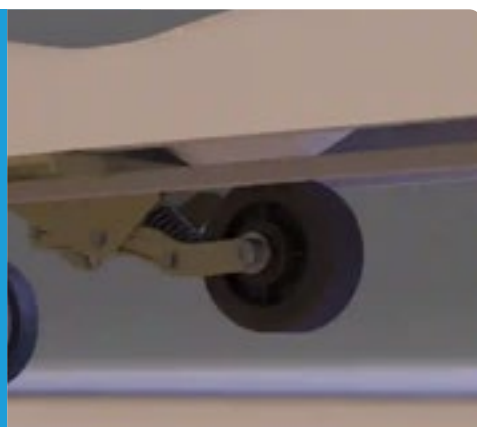

### CYBER BED

### KIT Cyberbed\*

ACO 78



ACO 79  
Bateria



ACO 24  
Suporte p/  
oxigênio



ACO 85  
Movimento  
One Touch

## Toda linha de UTI possui:



CPR One touch



Grades com trava



Bumper



Sup. p/ bolsa de líquidos



Movimentos Motorizados



Compensação Abdominal



Suporte p/ Soro

## Lista de Opcionais:

**Raio X**  
ACO 95



**Colchão**

MT 672 - Laminado  
MT 660 - Colméia  
MT 666 - Viscoelástico



**Freio individual**  
ACO 06



**Personalizações**

ACO 43 - Peseira/Cabeceira  
ACO 42 - Grades



**Controle Remoto**  
ACO 60



**Suporte p/ soro**  
MT - 935



**Digital**

ACO 67 - Lado Direito  
ACO 68 - Completo  
ACO 69 - Supervisor S/ Display  
ACO 70 - Supervisor C/ Display



**Quinta Roda**  
ACO 34

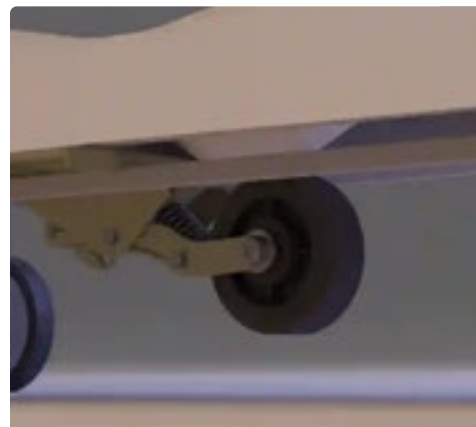

**Kit Balança**  
ACO 84



**CYBER BED**

**KIT Cyberbed**  
ACO 78



ACO 79  
Bateria



ACO 24  
Suporte p/  
oxigênio



ACO 85  
Movimento  
One Touch

## Toda linha de UTI possui:



CPR One touch



Grades com trava



Bumper

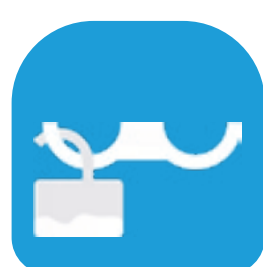

Sup. p/ bolsa de líquidos



Movimentos Motorizados



Compensação Abdominal

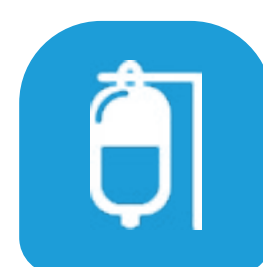

Suporte p/ Soro

## Lista de Opcionais:

**Raio X**  
ACO 93

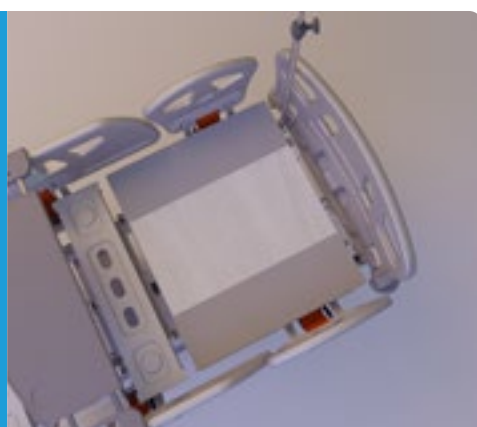

**Colchão**

MT 672 - Laminado  
MT 660 - Colméia  
MT 666 - Viscoelástico

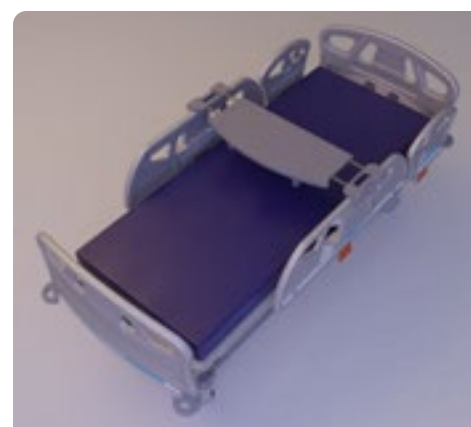

**Rodas e Freio**

ACO 07 - FT/FD 6"  
ACO 06 - 6"  
ACO 05 - Roda 4"



**Personalizações**

ACO 44 - Grades  
ACO 45 - Peseira/Cabeceira



**Carenagem**  
ACO 31



**Suporte p/ Soro**  
MT - 935



**Digital**

ACO 64 - Lado Direito  
ACO 65 - Completo  
ACO 66 - Supervisor s/ Display



**Quinta Roda**  
ACO 34



**Sexta grade**  
ACO 52



**Protetor de Parede**  
ACO 30



ACO 79  
Bateria



ACO 23  
Suporte p/  
oxigênio



ACO 85  
Movimento  
One Touch



Para facilitar o dia a dia da equipe médica, desenvolvemos a função de mudança de ângulo programado a um toque\*



As grades de proteção total + elevadas reduzem quedas de pacientes



A inovadora espuma de alta densidade Metahospitalar aliada a função Prona-PRO previne ferimentos por pressão



## RECURSOS PADRÕES

- Inclinação lateral.
- Colunas.
- Poltrona ONE TOUCH.
- Raio X no dorso.
- Controle duplo nas grades.

- Grade de proteção total.
- Supervisor display.
- Freios total e direcional.
- Extensor de cama.
- Rodízios de 6”.

Projetada para receber modernidades exclusivas:

# CYBERBED



A cama com tecnologia embarcada para a Conectividade com sistemas de gestão e outros equipamentos hospitalares. O software de conectividade e monitoramento das camas. Está disponível em dois módulos: Assistencial & Engenharia Clínica.

## MOVIMENTOS DO LEITO

Fowler Dorso	Fowler Pernas	Trend	Proclive	Elevação mínima	Elevação máxima	Posição Poltrona
0 - 77°	0° - 23°	-15°	+ 15°	520mm	720mm	

Transversal  
-30° à 30°



Reduz o tempo de internação de pacientes e evita lesões.



### DADOS TÉCNICOS

Leito: Comp: 1950mm; Largura: 830mm;  
Total: Comp: 2280mm com extensor;  
Largura: 1090mm; Altura: 520 - 720mm.

Clique para ver a lista de opcionais

**OPCIONAIS**



Redução de lesão por pressão, garantindo a redistribuição do peso, propondo maior conforto ao paciente



Toque no movimento da poltrona e a cama se posiciona automaticamente



Saída facilitada do paciente do leito com apoio lateral nas grades



## RECURSOS PADRÕES

- 8 movimentos ONE TOUCH.
- Raio X no dorso.
- Controle duplo nas grades.
- Supervisor display.
- Freios total e direcional.
- Rodizio de 6 e 8".
- Extensor de cama motorizado.
- Leito em TS.
- Touch screen
- 6 motores
- Luz Noturna

Projetada para receber modernidades exclusivas:

# CYBERBED



A cama com tecnologia embarcada para a Conectividade com sistemas de gestão e outros equipamentos hospitalares. O software de conectividade e monitoramento das camas. Está disponível em dois módulos: Assistencial & Engenharia Clínica.

## MOVIMENTOS DO LEITO



Fowler  
Pernas

0° - 23°



Trend

-15°



Procline

+15°



Elevação  
mínima

480mm



Elevação  
máxima

810mm

## Poltrona Cardíaca



Fowler  
Dorso

0° - 90°



Poltrona  
cardíaca



Auxílio  
saída do  
paciente



### DADOS TÉCNICOS

Leito: Comp: 1950mm; Largura: 830mm;  
Total: Comp: 2280mm com extensor;  
Largura: 1090mm; Altura: 480 - 810mm.

Clique para ver a lista de opcionais

**OPCIONAIS**

Painel supervisor com display com balança



As grades de proteção total + elevadas evitam queda do paciente



É estruturada por 2 colunas que realizam 7 movimentos, incluindo poltrona e suportam uma carga total de até 300 Kg



## RECURSOS PADRÕES

- Raio X no dorso.
- Controle duplo nas grades.
- Poltrona ONE TOUCH.
- Supervisor display.
- Colunas.
- Freios total e direcional.
- Rodizio de 6".
- Grade de proteção total.
- Descanso de perna elétrico.
- Leito removível.

Projetada para receber modernidades exclusivas:

# CYBERBED



A cama com tecnologia embarcada para a Conectividade com sistemas de gestão e outros equipamentos hospitalares. O software de conectividade e monitoramento das camas. Está disponível em dois módulos: Assistencial & Engenharia Clínica.

## MOVIMENTOS DO LEITO

Fowler Dorso	Fowler Pernas	Trend	Proclive	Elevação mínima	Elevação máxima	Posição Poltrona
0 - 77°	0° - 23°	-15°	+ 15°	480mm	680mm	



### DADOS TÉCNICOS

Leito: Comp: 1950mm; Largura: 830mm;  
Total: Comp: 2280mm com extensor;  
Largura: 1090mm; Altura: 480 - 680mm.

Clique para ver a lista de opcionais

**OPCIONAIS**





Painel supervisor com display



Sistema de elevação de grades que não ocupa espaço



Grades com leds que podem mudar de cor de acordo com os protocolos de atendimento do Hospital



280Kg

\*Mesa de refeição não acompanha o produto



## RECURSOS PADRÕES

- Raio X no dorso.
- Controle duplo nas grades.
- Supervisor display.
- Freios total e direcional.
- Rodizio de 6”.
- Grades com rota de fuga.
- Suporte p/ tábua de massagem cardíaca e mesa de refeição.

Projetada para receber modernidades exclusivas:

# CYBERBED



A cama com tecnologia embarcada para a Conectividade com sistemas de gestão e outros equipamentos hospitalares. O software de conectividade e monitoramento das camas. Está disponível em dois módulos: Assistencial & Engenharia Clínica.

## MOVIMENTOS DO LEITO



Fowler Dorso

0 - 77°



Fowler Pernas

0° - 23°



Trend

-15°



Proclive

+15°



Elevação mínima

330mm



Elevação máxima

680mm



Posição Poltrona



### DADOS TÉCNICOS

Leito: Comp: 1950mm; Largura: 830mm;  
Total: Comp: 2280mm com extensor;  
Largura: 1090mm; Altura: 330 - 680mm.

Clique para ver a lista de opcionais

**OPCIONAIS**

O melhor custo-benefício!



As cabeceiras em polietileno são removíveis e com sistema exclusivo de travamento



As rodas são de 06 polegadas com freio total e direcional



 280Kg



## RECURSOS PADRÕES

- Leito removível.
- Controle duplo na grade direita.
- Grade de proteção total.
- Grade com descida amortecida.
- Freios total e direcional.
- Rodizio de 6".
- Extensor de leito.
- Base com carenagem.







Projetada para receber modernidades exclusivas:

# CYBERBED



A cama com tecnologia embarcada para a Conectividade com sistemas de gestão e outros equipamentos hospitalares. O software de conectividade e monitoramento das camas. Está disponível em dois módulos: Assistencial & Engenharia Clínica.

## MOVIMENTOS DO LEITO

						
Fowler Dorso	Fowler Pernas	Trend	Proclive	Elevação mínima	Elevação máxima	Posição Poltrona
0 - 77°	0° - 23°	-15°	+ 15°	390mm	740mm	



### DADOS TÉCNICOS

Leito: Comp: ≈1950mm; Largura: 830mm;  
Total: Comp: ≈2280mm com extensor;  
Largura: 1090mm; Altura: 390 -740mm.

Clique para ver a lista de opcionais

**OPCIONAIS**

Quatro grades em polietileno, com opcional de até seis grades p/ o enclausuramento completo



O controle remoto auxilia o paciente e a equipe assistencial no dia a dia



A grade de produtos Flex possui variados acessórios que possibilitam diferentes personalizações



**280Kg**



## RECURSOS PADRÕES

- Leito removível
- Controle duplo na grade direita.
- Grade de proteção total.
- Grade com descida amortecida.
- Freios total e direcional.
- Rodizio de 5".
- Extensor de leito.
- Caixa de Personalização.



Mesa de Refeição Flex\*

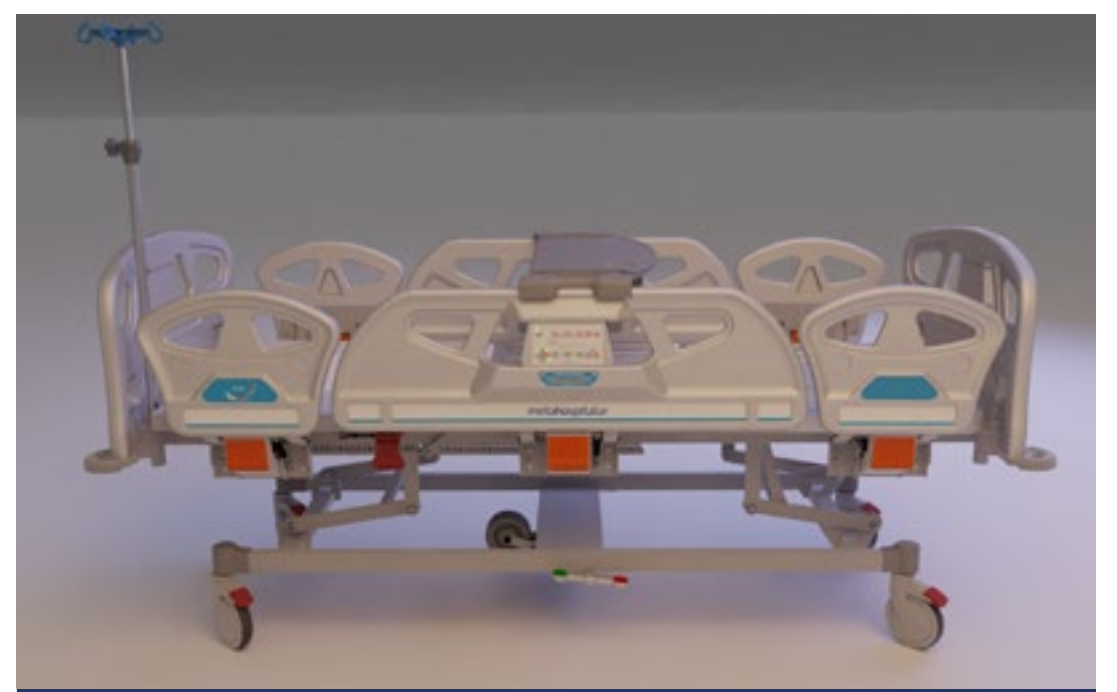

Seis Grades\*

## MOVIMENTOS DO LEITO



**Fowler Dorso**

0 - 77°



**Fowler Pernas**

0° - 23°



**Trend**

-15°



**Procline**

+15°



**Elevação mínima**

390mm



**Elevação máxima**

740mm



**Posição Poltrona**



### DADOS TÉCNICOS

Leito: Comp: ≈1950mm; Largura: 830mm;  
Total: Comp: ≈2170mm com extensor;  
Largura: 970mm; Altura: 390 -740mm.

\*Opcionais

Clique para ver a lista de opcionais

**OPCIONAIS**



CAMAS CUIDADOS A

**LONGO PRAZO**

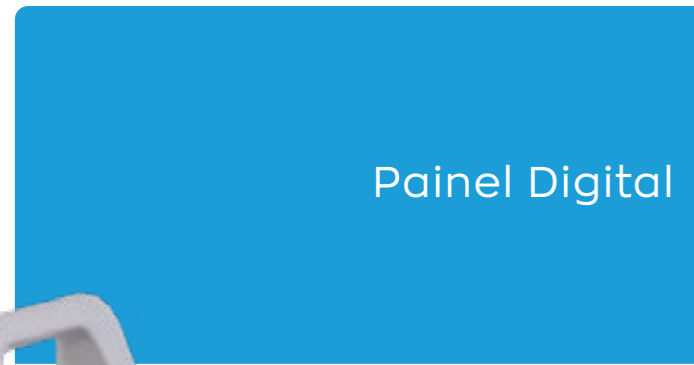

Painel Digital

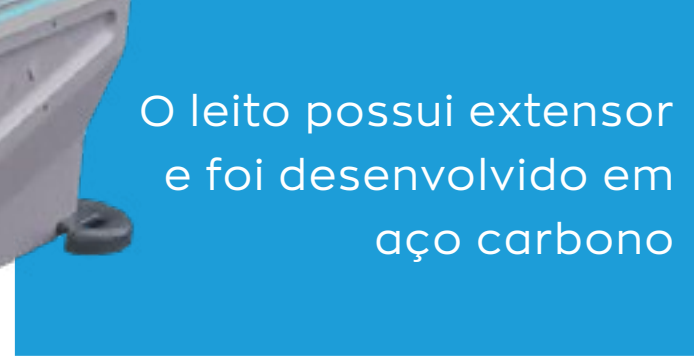

O leito possui extensor e foi desenvolvido em aço carbono

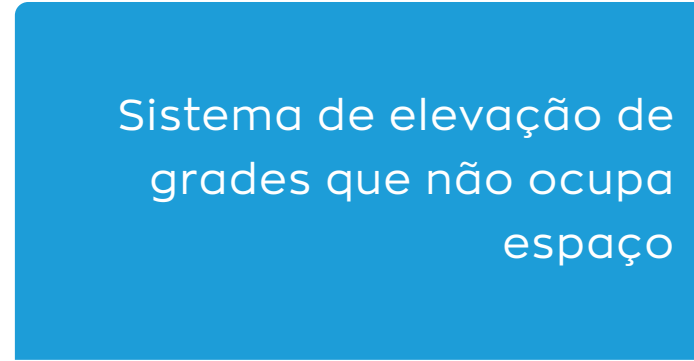

Sistema de elevação de grades que não ocupa espaço



280Kg

\*Mesa de refeição não acompanha o produto



## RECURSOS PADRÕES

- Leito removível
- Controle duplo nas grades.
- Grades com rota de fuga.
- Supervisor display.
- Freios total e direcional.
- Rodizio de 6".
- Extensor de leito.



Mesa de Refeição Diamond\*



Tábua p/ Massagem Cardíaca\*

## MOVIMENTOS DO LEITO

Fowler Dorso	Fowler Pernas	Trend	Procline	Elevação mínima	Elevação máxima	Posição Poltrona
0 - 77°	0° - 23°	-15°	+ 15°	330mm	680mm	



### DADOS TÉCNICOS

Leito: Comp: ≈1950mm; Largura: 830mm;  
Total: Comp: ≈2280mm com extensor;  
Largura: 1090mm; Altura: 330 - 680mm.

\*Opcionais

Clique para ver a lista de opcionais

**OPCIONAIS**



Robusta e Segura



As cabeceiras em polietileno são removíveis e com sistema exclusivo de travamento



As rodas são de 06 polegadas com freio Individual



280Kg



## RECURSOS PADRÕES

- Leito removível.
- Controle duplo na grade direita.
- Grade de proteção total.
- Grade com descida amortecida.
- Freio total nas 04 rodas.
- Rodizio de 5".
- Extensor de leito.
- Base com carenagem.



Controle digital Interno e externo



Bandejas removíveis

## MOVIMENTOS DO LEITO

Fowler Dorso	Fowler Pernas	Trend	Procline	Elevação mínima	Elevação máxima	Posição Poltrona
0 - 77°	0° - 23°	-15°	+ 15°	330mm	680mm	



### DADOS TÉCNICOS

Leito: Comp: ≈1950mm; Largura: 830mm;  
Total: Comp: ≈2280mm com extensor;  
Largura: 1090mm; Altura: 330 - 680mm.

Clique para ver a lista de opcionais

**OPCIONAIS**



Possui extensor de leito com cabeceira e pesseira removíveis



Por ter um tamanho compacto, esta cama se adapta aos grandes centros urbanos



Sua lista de opcionais é diversa, acompanhando a grade de produtos Flex



## RECURSOS PADRÕES

- Leito removível.
- Grade com descida amortecida.
- Freio individual nas 04 rodas.
- Rodizio de 4”.
- Extensor de leito.

- Base com carenagem parcial.



Controle remoto



Bandejas removíveis

## MOVIMENTOS DO LEITO



Fowler Dorso

0 - 77°



Fowler Pernas

0° - 23°



Trend

-15°



Procline

+15°



Elevação mínima

390mm



Elevação máxima

740mm



Posição Poltrona



### DADOS TÉCNICOS

Leito: Comp: 1750mm; Largura: 700mm;  
Total: Comp: 1980mm com extensor;  
Largura: 880mm; Altura: 390 - 740mm.

Clique para ver a lista de opcionais

**OPCIONAIS**



Quatro grades em polietileno, com opcional de até seis grades p/ o enclausuramento completo



O controle remoto auxilia o paciente e a equipe assistencial no dia a dia



A grade de produtos Flex possui variados acessórios que possibilitam diferentes personalizações



## RECURSOS PADRÕES

- Leito removível.
- Grade com descida amortecida.
- Freio individual nas 04 rodas.
- Rodizio de 4”.
- Extensor de leito.

- Base com carenagem parcial.

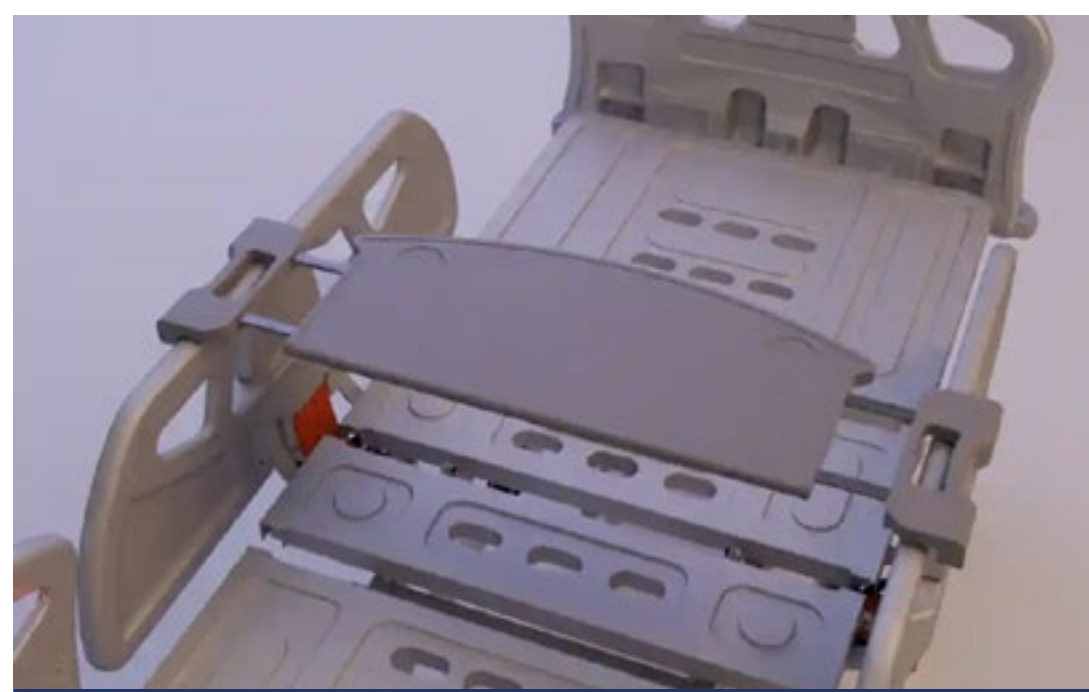

Mesa de Refeição Flex\*



Seis Grades\*

## MOVIMENTOS DO LEITO



Fowler Dorso

0 - 77°



Fowler Pernas

0° - 23°



Trend

-15°



Procline

+15°



Elevação mínima

330mm



Elevação máxima

680mm



Posição Poltrona



### DADOS TÉCNICOS

Leito: Comp: 1950mm; Largura: 830mm;  
Total: Comp: 2170mm com extensor;  
Largura: 1090mm; Altura: 330 - 680mm.

Clique para ver a lista de opcionais

**OPCIONAIS**





Quatro grades em polietileno, com opcional de até seis grades p/ o enclausuramento completo



Elevação manual



A grade de produtos Flex possui variados acessórios que possibilitam diferentes personalizações



**280Kg**



\*Mesa de refeição não acompanha o produto

**RECURSOS PADRÕES**

- Leito removível.
- Grade com descida amortecida.
- Freio individual nas 04 rodas.
- Rodizio de 4”.
- Base com carenagem parcial.



Mesa de Refeição Flex\*



Seis Grades\*

**MOVIMENTOS DO LEITO**

Fowler Dorso	Fowler Pernas	Trend	Proclive	Elevação mínima	Elevação máxima	Posição Poltrona
0 - 80°	0° - 25°	-12°	+ 12°	440mm	750mm	



**DADOS TÉCNICOS**  
 Leito: Comp: 1950mm; Largura: 830mm;  
 Total: Comp: 2170mm com extensor;  
 Largura: 970mm; Altura: 440 - 750mm.

Clique para ver a lista de opcionais

**OPCIONAIS**

\*Opcionais



MACAS E CADEIRAS DE

# TRANSPORTE

## Lista de Opcionais:

### Quinta Roda

ACO 09  
ACO 10 - F1



### Colchonete

MT 687 - 7cm  
MT 670 - C/ Raio X



### Sup p/ Monitor

ACO 11



### Régua Tripla

ACO 29



### Personalização

ACO 44



### Colchonete 7cm

MT 689 - P/ MT 414  
MT 687 - P/ MT 413



### Freio Total

ACO 07

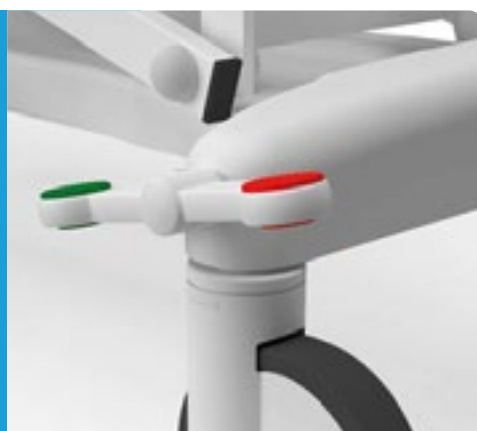

### Régua Tripla

ACO 29



### Sup p/ Monitor

ACO 12 - P/ MT 414  
ACO 13 - P/ MT 413



### Guiador

ACO 14 - P/ MT 414  
ACO 15 - P/ MT 413



MT - 935  
Suporte p/  
Soro



ACO 24  
Suporte p/  
oxigênio

Diamond Care

Flex Care

# Cadeira para Transporte | MT 450



Seu design possibilita encaixar em qualquer espaço



Acolchoado com espuma de alta densidade e Revestimento em couro ecológico



Suporte p/ Oxigênio e Arquivos



180Kg



## RECURSOS PADRÕES

- Braços rebatíveis com revestimento emborrachado.
- Rodizio de 4" e 8" anti ruído.
- Guiador emborrachado.
- Freio central traseiro.

- Freio individual.
- Pedais para elevação.
- Carenagem.
- Sistema acionado através de mola a gás.



Suporte p/ Soro



Suporte p/ Sacos Foley e Maleta



Apoio rebatível para Pés



Perneiras



## DADOS TÉCNICOS

Comp: ≈1170mm; Largura: ≈750mm; Altura: ≈570mm.

\*Imagem meramente ilustrativa. Cilindro de Oxigênio, bolsa e pasta não estão inclusos.

VOLTAR PARA

**ÍNDICE**

# Carro Maca Coluna | MT 418



O sistema de elevação é acionado através de pedais que movimentam duas colunas com muita facilidade



Sua base possui suporte p/ maleta e suporte p/ cilindro de oxigênio

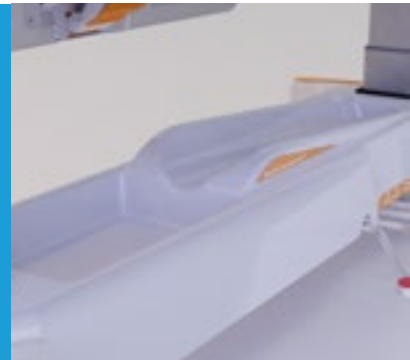

Fácil dirigibilidade



**280Kg**



## RECURSOS PADRÕES

- Carenagem de alta resistência e fácil limpeza.
- Conjunto de grades diamond.
- Parachoque laranja p/ proteção completa.
- Sistema acionado através de mola a gás.
- Rodas de 8”.
- Quinta Roda.
- Freio total e direcional em 2 pedais.



Tábua de Massagem Cardíaca

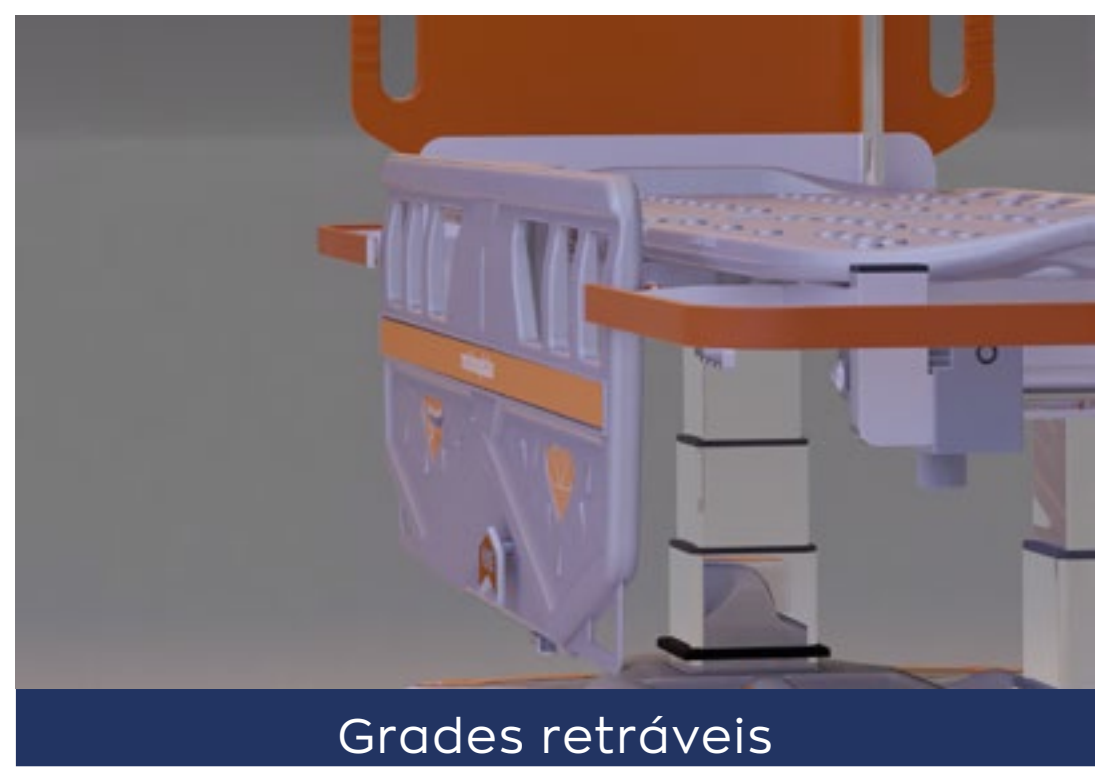

Grades retráveis

## MOVIMENTOS DO LEITO

Fowler Dorso	Fowler Pernas	Trend	Proclive	Elevação mínima	Elevação máxima
0-90°	0° - 30°	-15°	+ 15°	595mm	915mm



### DADOS TÉCNICOS

Leito: Comp: 1870mm; Largura: 600mm;  
 Total: Comp: 2130mm;  
 Largura: 790mm; Altura: 595 - 915mm.

Clique para ver a lista de opcionais

**OPCIONAIS**



O sistema de elevação é acionado através de pedais que movimentam duas colunas com muita facilidade

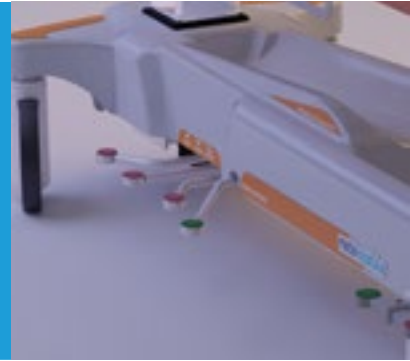

Sua base possui suporte p/ maleta e suporte p/ cilindro de oxigênio

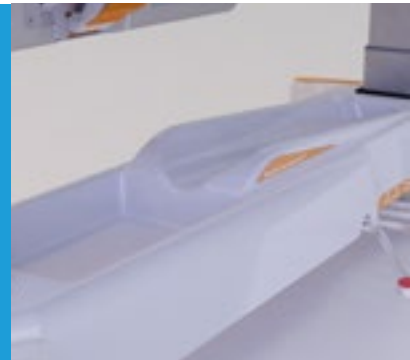

Fácil dirigibilidade



 280Kg



## RECURSOS PADRÕES

- Carenagem de alta resistência e fácil limpeza.
- Conjunto de grades diamond.
- Parachoque laranja p/ proteção completa.

- Sistema acionado através de mola a gás.
- Rodas de 8”.
- Freio total e direcional em 2 pedais.









Tábua de Massagem Cardíaca



Grades retráveis

## MOVIMENTOS DO LEITO

					
Fowler Dorso	Fowler Pernas	Trend	Proclive	Elevação mínima	Elevação máxima
0-90°	0° - 30°	-15°	+ 15°	595mm	915mm



### DADOS TÉCNICOS

Leito: Comp: 1870mm; Largura: 600mm;  
Total: Comp: 2130mm;  
Largura: 790mm; Altura: 595 - 915mm.

Clique para ver a lista de opcionais

**OPCIONAIS**



Freio individual por roda e quinta roda



Leito articulado em 4 sessões



Maior capacidade de volume



## RECURSOS PADRÕES

- Estrutura metálica com pintura eletrostática.
- Rodas de 5" de alta resistência.
- Freio individual.
- Quinta roda acionada por pedal.
- Pedais de fácil acionamento para elevação.
- Parachoque laranja p/ proteção completa.
- Carenagem de alta resistência e fácil limpeza.



Suporte para Oxigênio

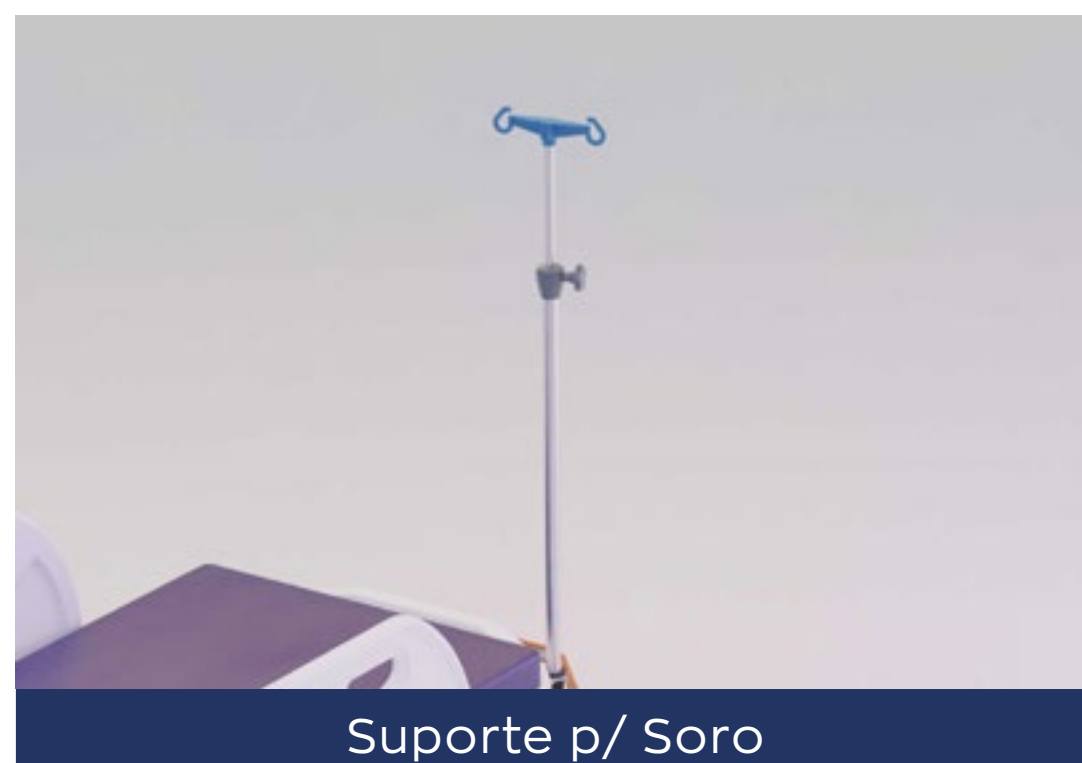

Suporte p/ Soro

## MOVIMENTOS DO LEITO

Fowler Dorso	Fowler Pernas	Trend	Proclive	Elevação mínima	Elevação máxima
0-90°	0° - 30°	-15°	+ 15°	670mm	960mm



### DADOS TÉCNICOS

Leito: Comp: 1870mm; Largura: 700mm;  
Total: Comp: 2070mm;  
Largura: 880mm; Altura: 670 - 960mm.

Clique para ver a lista de opcionais

**OPCIONAIS**

VOLTAR PARA  
**ÍNDICE**

# Carro Maca 600mm | MT 413

  
230Kg



Freio individual



Leito articulado em 4 sessões



Perfeito p/ espaços reduzidos



## RECURSOS PADRÕES

- Estrutura metálica com pintura eletrostática.
- Rodas de 5" de alta resistência.
- Freio individual.
- Quinta roda acionada por pedal.

- Pedais de fácil acionamento para elevação.
- Parachoque laranja p/ proteção completa.
- Carenagem de alta resistência e fácil limpeza.





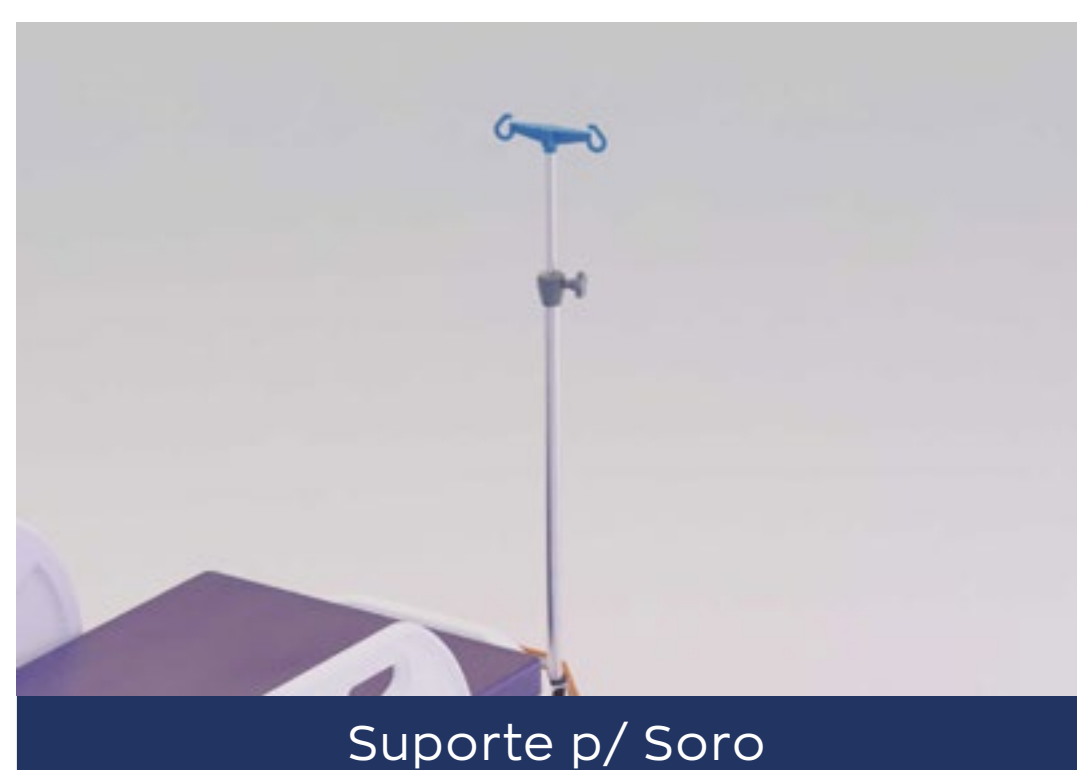



Suporte para Oxigênio



Suporte p/ Soro

## MOVIMENTOS DO LEITO

					
Fowler Dorso	Fowler Pernas	Trend	Proclive	Elevação mínima	Elevação máxima
0-90°	0° - 30°	-15°	+15°	670mm	960mm

## DADOS TÉCNICOS

Leito: Comp: 1870mm; Largura: 600mm;  
Total: Comp: 2070mm;  
Largura: 780mm; Altura: 670 - 960mm.

Clique para ver a lista de opcionais

**OPCIONAIS**





Freio individual por roda

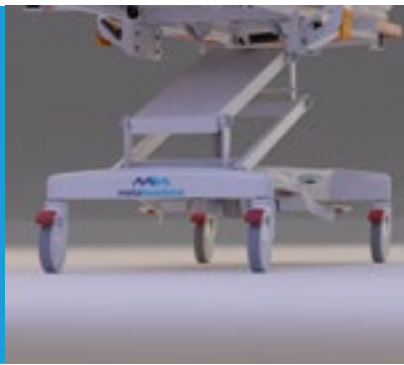

Parachoque laranja p/  
proteção completa

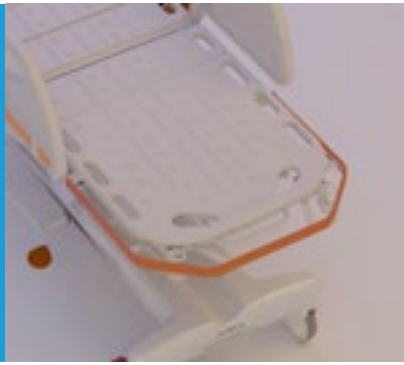

Leve e ágil



 230Kg



## RECURSOS PADRÕES

- Estrutura metálica com pintura eletrostática.
- Rodas de 5" de alta resistência.
- Freio individual.
- Pedais de fácil acionamento para

elevação.

- Conjunto de grades retráteis em termoplástico.
- Carenagem de alta resistência e fácil limpeza.



Suporte para Oxigênio

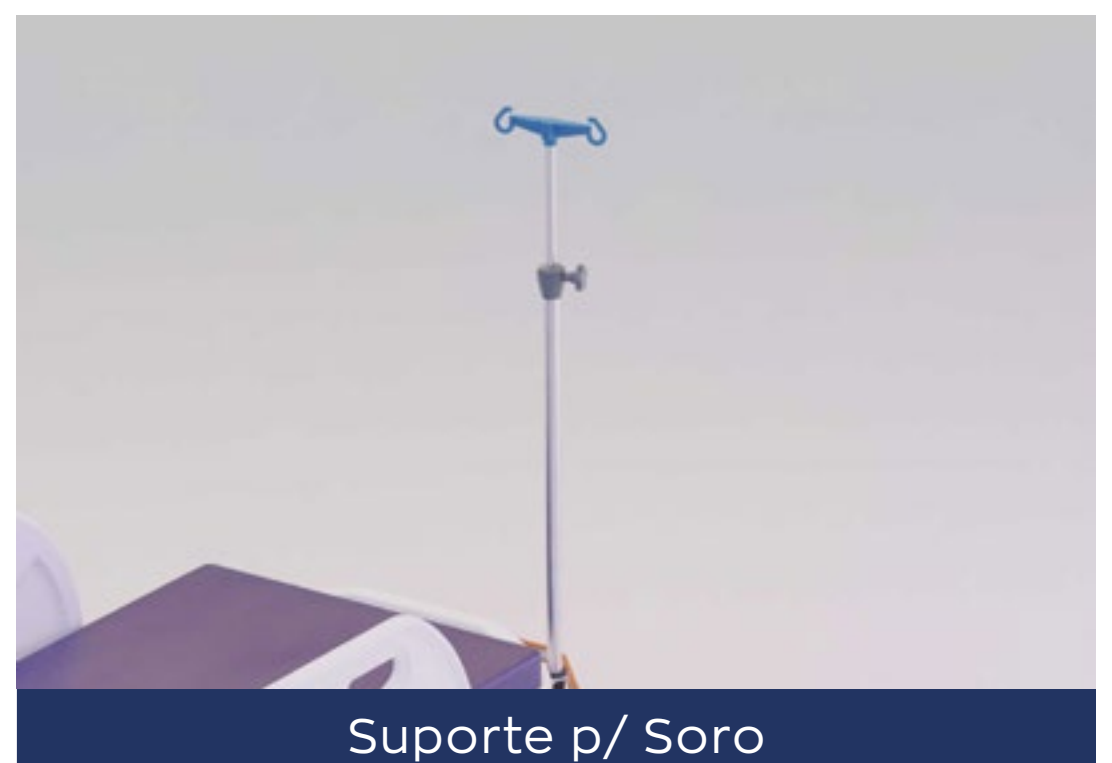

Suporte p/ Soro

## MOVIMENTOS DO LEITO



Fowler  
Dorso

0-90°



Elevação  
mínima

670mm



Elevação  
máxima

960mm



### DADOS TÉCNICOS

Leito: Comp: 1830mm; Largura: 600mm;  
Total: Comp: 1990mm;  
Largura: 780mm; Altura: 670 - 960mm.

Clique para ver a lista de opcionais

**OPCIONAIS**



CAMAS

PPP E INFANTIL



Apoio p/ as coxas e pés retráteis com regulagem de longitude e lateral



Alavanca de esforço lateral retrátil



Fabricado em espuma injetada



250Kg



**RECURSOS PADRÕES**

- CPR ONE TOUCH.
- Poltrona ONE TOUCH.
- Controle duplo nas grades.
- Peseira removível para parto.
- Conjunto de grades Diamond.

- Rodízio de 6” com freio total e direcional.
- Para-choque.
- Suporte p/ Soro.

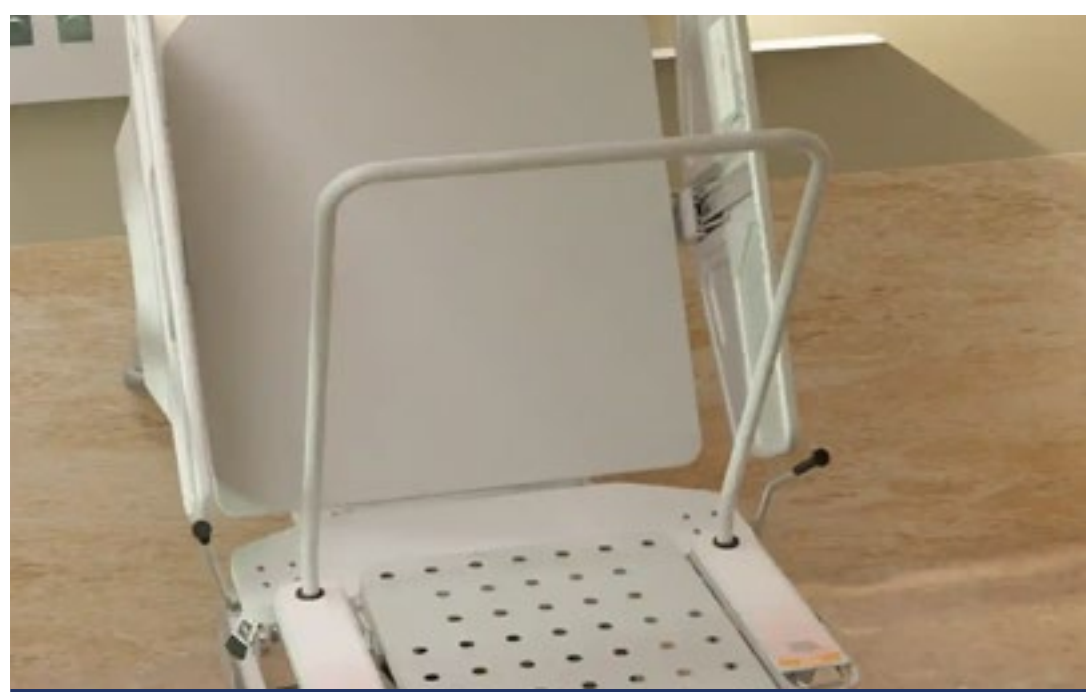

Arco de esforço removível



Bacia removível para coleta

**MOVIMENTOS DO LEITO**



Fowler Dorso

0 - 77°



Trend

-15° + 15°



Proclive



Elevação mínima

465mm



Elevação máxima

820mm



Posição Poltrona

**Posições de Parto**



**DADOS TÉCNICOS**

Leito: Comp: ≈1900mm; Largura: 980mm;  
Total: Comp: ≈1600mm;  
Largura: 900mm; Altura: 465 - 820mm.



Apoio p/ as coxas e pés retráteis com regulagem de longitude e lateral



Alavanca de esforço lateral retrátil



Fabricado em espuma injetada



 250Kg



### RECURSOS PADRÕES

- Peseira removível para parto.
- Suporte p/ Soro.
- Rodízio de 5" com freio individual.
- Conjunto de grades retráteis em termoplástico.

- Armazenamento da peseira.

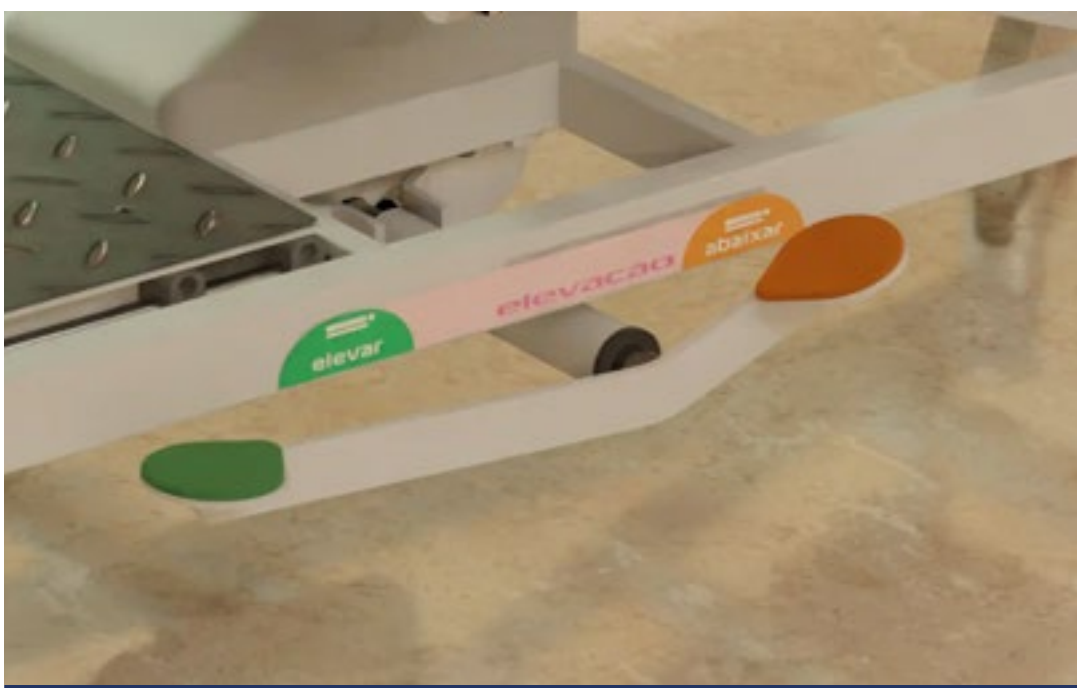

Pedais para elevação



Bacia removível para coleta

### MOVIMENTOS DO LEITO



Fowler Dorso

0 - 77°



Trend

-15°



Procline

+ 15°



Elevação mínima

630mm



Elevação máxima

840mm



Posição Poltrona

### Posições de Parto



### DADOS TÉCNICOS

Leito: Comp: ≈1980mm; Largura: 800mm;  
Total: Comp: ≈2300mm;  
Largura: 1050mm; Altura: 630 - 840mm.



180Kg



As janelas em acrílico asseguram uma visualização nítida da equipe ao paciente e vice versa



Colunas em inox



Visual único e exclusivo



## RECURSOS PADRÕES

- Conjunto de grades Diamond.
- Rodízios de 5" com freio individual.
- Peseira e cabeceira com elevação.
- Leito articulado em termoplástico removível.

- Parachoque.



Grades Abaixadas



Janelas em acrílico com reforço

## MOVIMENTOS DO LEITO



Fowler  
Dorso

0 - 77°



Fowler  
Pernas

0° - 23°



### DADOS TÉCNICOS

Leito: Comp: ≈1350mm; Largura: 700mm;  
Total: Comp: 1620mm;  
Largura: 910mm; Altura: 740mm.



180Kg



As janelas em acrílico asseguram uma visualização nítida da equipe ao paciente e vice versa



Colunas em inox



Visual único e exclusivo



**RECURSOS PADRÕES**

- Conjunto de grades Diamond.
- Rodízios de 5" com freio individual.
- Peseira e cabeceira com elevação.
- Leito articulado em termoplástico removível.

- Parachoque.



Grades Abaixadas



Janelas em acrílico com reforço

**MOVIMENTOS DO LEITO**



Fowler Dorso

0 - 77°



Fowler Pernas

0° - 23°



Trend

-15°



Procline

+15°



Elevação mínima

840mm



Elevação máxima

1040mm



Posição Poltrona



**DADOS TÉCNICOS**

Leito: Comp: ≈1350mm; Largura: 700mm;  
Total: Comp: 1620mm;  
Largura: 910mm; Altura: 840 - 1040mm.

\*Imagem meramente ilustrativa. Colchão e almofadas não estão inclusos.



Ela pode se tornar infantil ou adulto com o extensor de leito



Controle remoto



Leito removível em termoplástico



280Kg



**RECURSOS PADRÕES**

- Carenagem Parcial.
- Rodizios de 4" com freio individual.
- Conjunto de grades Diamond.
- Extensor de leito.



Grades que não ocupam espaço



Maior Versatilidade

**MOVIMENTOS DO LEITO**



Fowler Dorso

0 - 77°



Fowler Pernas

0° - 23°



Trend

-15°



Proclive

+15°



Elevação mínima

330mm



Elevação máxima

680mm



Posição Poltrona



**DADOS TÉCNICOS**

Leito: Comp: ≈1750mm; Largura: 830mm;  
Total: Comp: ≈2280mm com extensor;  
Largura: 1090mm; Altura: 330 - 680mm.



**SOFÁS**



## Lista de Opcionais:

**CR 101**

PRETO

**CR 103**

VERDE

**CR 106**

AZUL CLARO

**CR 115**

AZUL

**CR 116**

BEGE

**CR 127**

MARROM ESCURO

**CR 149**

AZUL ESCURO

**CR 158**

BEGE ESCURO

**CR 164**

MARROM

**CR 165**

AMARELO

**CR 166**

AZUL

**CR 41**

PRATA METALIZADO

**CR 42**

RATO METALIZADO

**CR 47**

AZUL METALIZADO

Costura embutida  
anti sujeira e  
impermeabilizante

Pés em termoplástico  
anti-risco resistente

Espuma D-28 e D-23 Soft

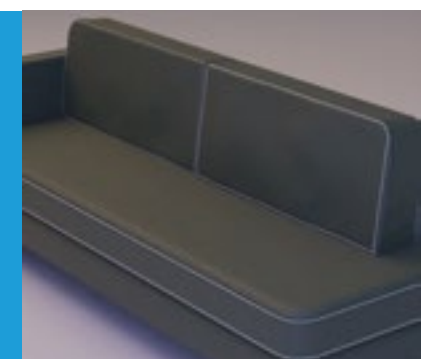

### RECURSOS PADRÕES

- 3 Lugares.
- Remoção do encosto/  
almofadas.
- Couro Ecológico.
- Madeira reflorestada.

- Braço alto do lado direito.
- Opcional costura rebatida.

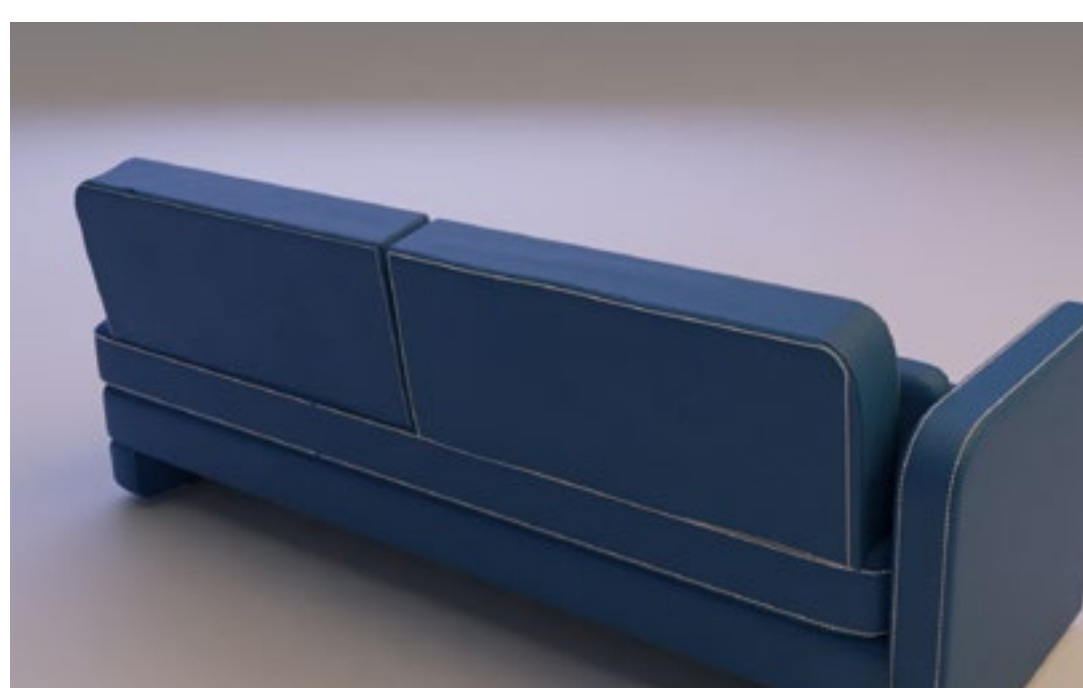

Remoção do encosto/almofadas

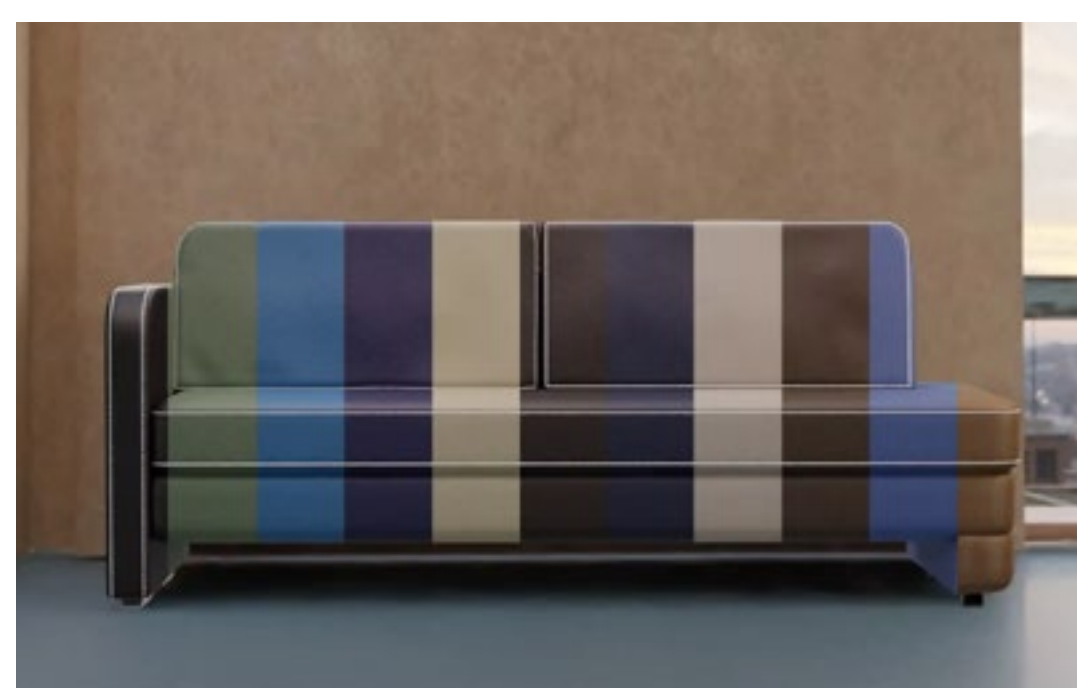

Diversas opções de Courvin



### DADOS TÉCNICOS

Comp: 2000mm; Largura: 930mm;  
Altura: ≈450mm.

**Clique aqui para acessar  
as opções de cores**

Costura embutida  
anti sujeira e  
impermeabilizante

Pés de aço Inox e  
plástico anti-risco

Espuma D-28 e D-23 Soft

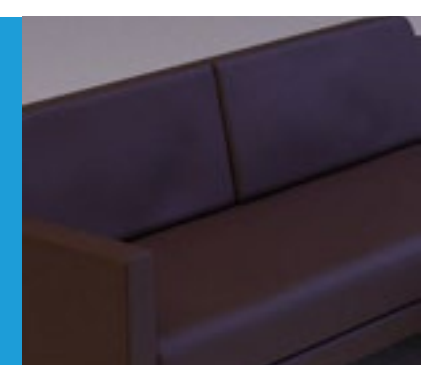

## RECURSOS PADRÕES

- 3 Lugares.
- Remoção do encosto/almofadas.
- Courvin Impermeável.
- Madeira reflorestada e aço inox.

- Braço alto do lado direito.



Remoção do encosto/almofadas

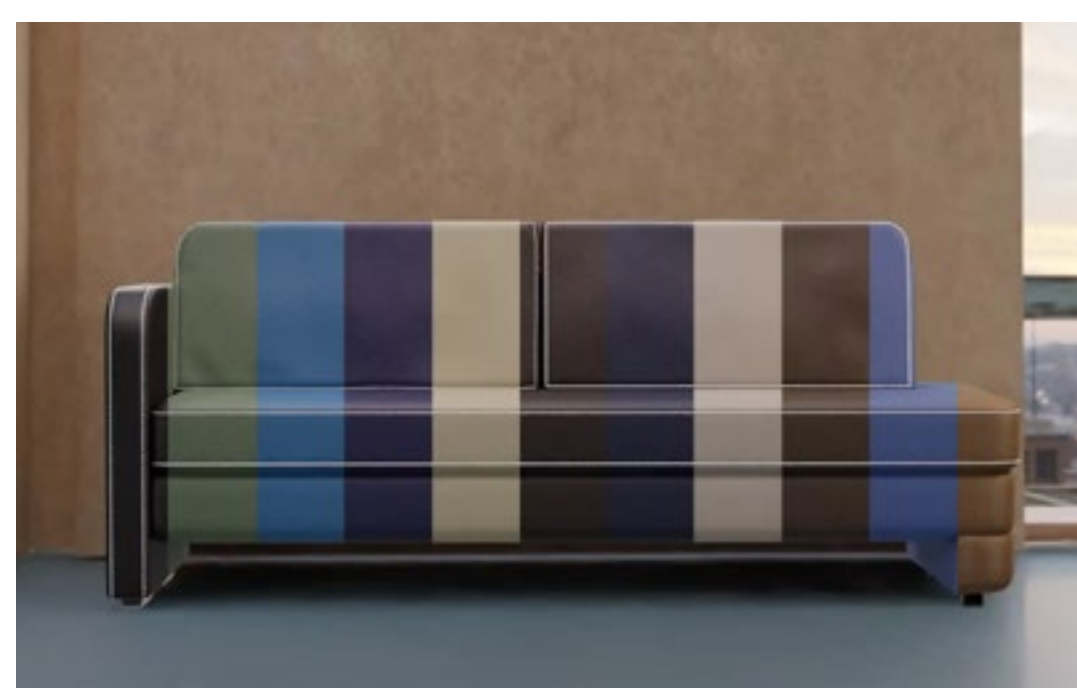

Diversas opções de Courvin



## DADOS TÉCNICOS

Comp: ≈1950mm; Largura: ≈930mm;  
Altura: ≈450mm.

**Clique aqui para acessar  
as opções de cores**



Costura embutida  
anti sujeira e  
impermeabilizante

Pés de aço Inox e  
plástico anti-risco

Espuma D-28 e D-23 Soft



## RECURSOS PADRÕES

- 2 Lugares.
- Remoção do encosto/  
almofadas.
- Courvin Impermeável.
- Madeira reflorestada e aço inox.

- Braço alto do lado direito.

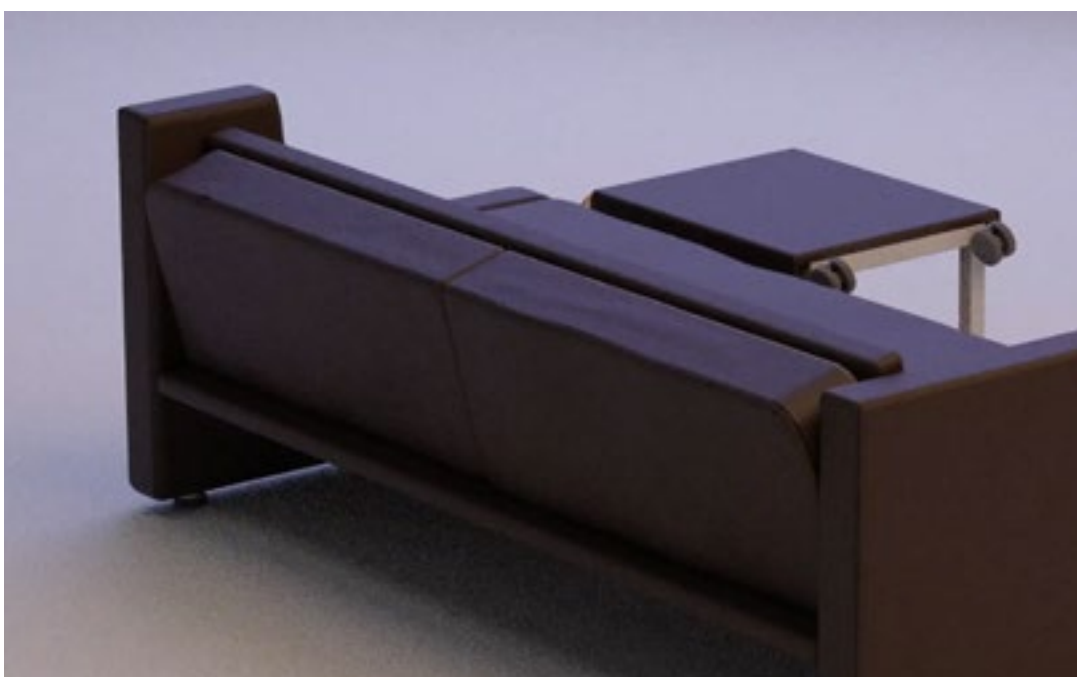

Remoção do encosto/almofadas



Diversas opções de Courvin



## DADOS TÉCNICOS

Comp: ≈1450mm; Largura: ≈870mm;  
Altura: ≈450mm.

**Clique aqui para acessar  
as opções de cores**



**POLTRONAS**



150Kg



Acolchoado de espumas  
D28 e soft D28

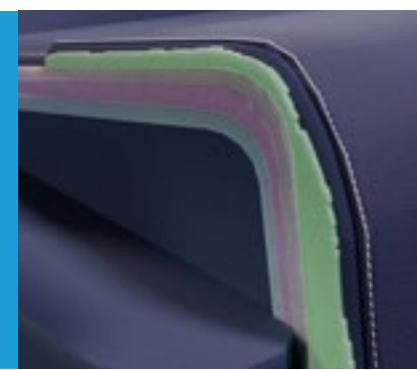

Movimentos motorizados



Encosto e assento  
anatômico

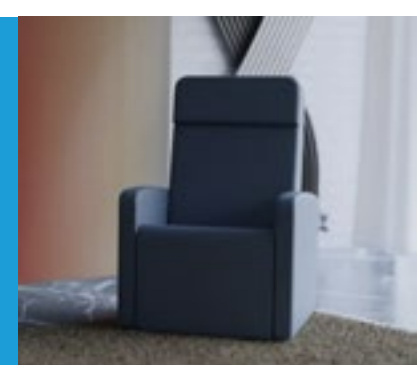

## RECURSOS PADRÕES

- Estrutura de madeira reconstituída.
- Costura rebatida.
- Superfície de Couro Ecológico.
- 2 movimentos.

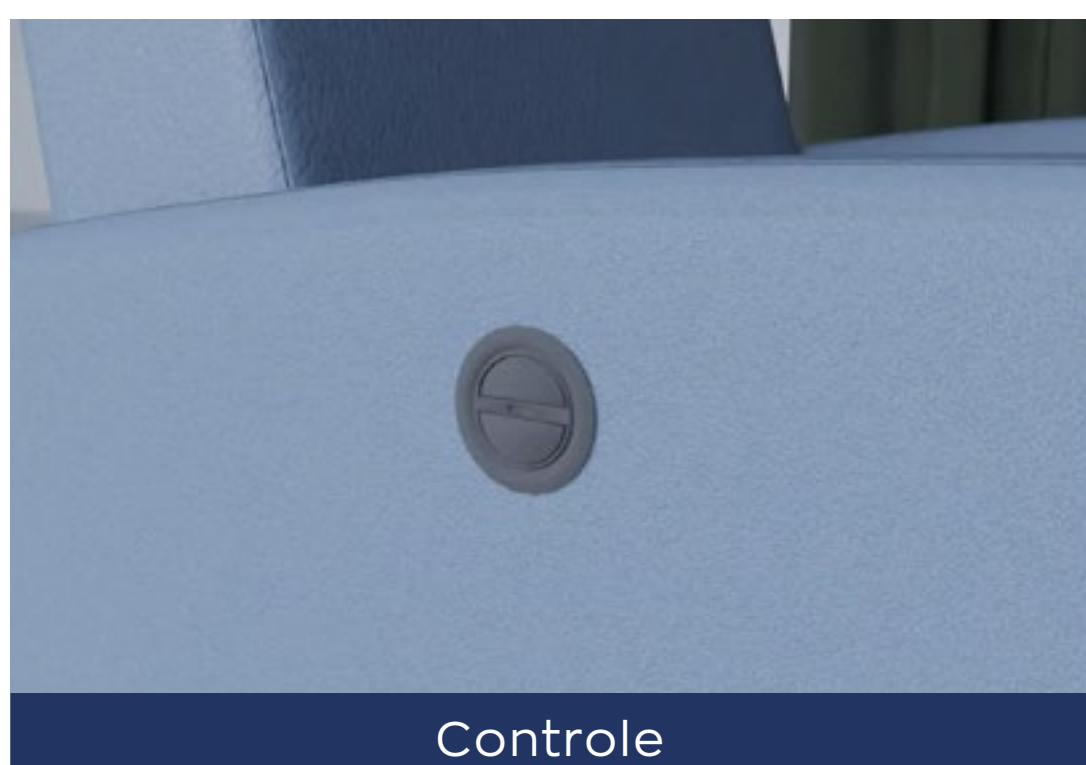

Controle



Diversas opções de Courvin

## MOVIMENTOS



Dorso



Pernas



### DADOS TÉCNICOS

Posição Normal: Comp: ≈870mm;  
Largura: ≈790mm; Altura: 490mm;  
Reclinada: ≈1600mm.

[Clique aqui para acessar  
as opções de cores](#)



Acolchoado de espumas D28 e soft D28



Movimentos motorizados



Encosto e assento anatômico



**RECURSOS PADRÕES**

- Estrutura de madeira reconstituída.
- Costura rebatida.
- Superfície de Couro Ecológico.
- 3 movimentos.



Movimento Saída do Paciente

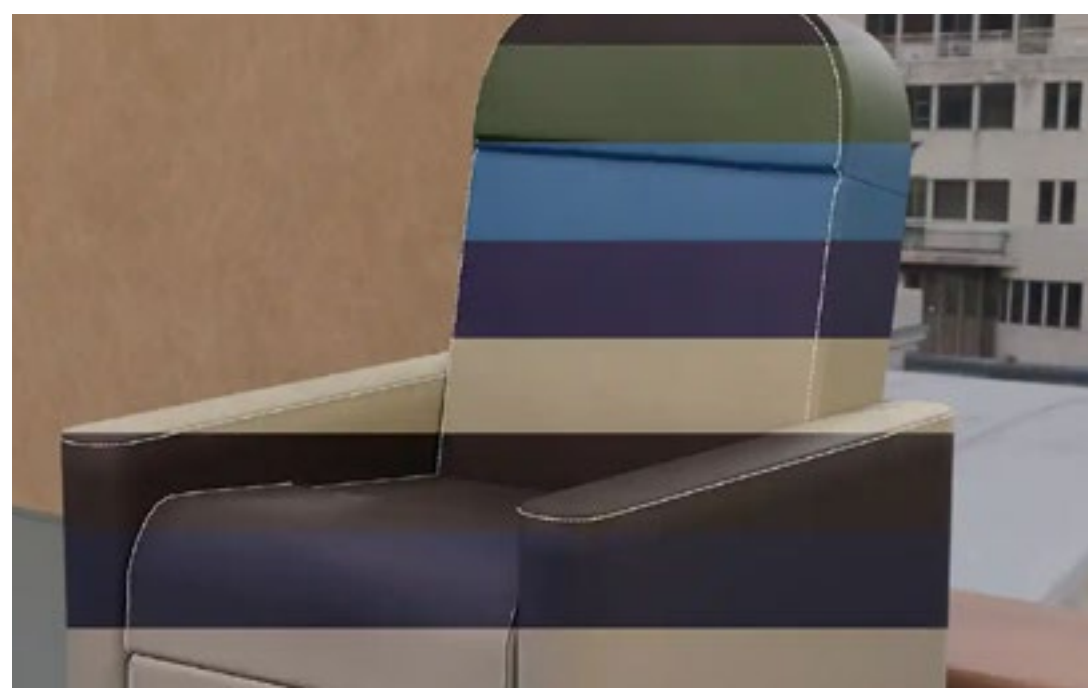

Diversas opções de Courvin

**MOVIMENTOS**



Dorso



Pernas



Saída do Paciente



**DADOS TÉCNICOS**

Posição Normal: Comp: ≈870mm;  
Largura: ≈790mm; Altura: 490mm;  
Reclinada: ≈1600mm.

**Clique aqui para acessar as opções de cores**



Acolchoado de espumas  
D28 e soft D28

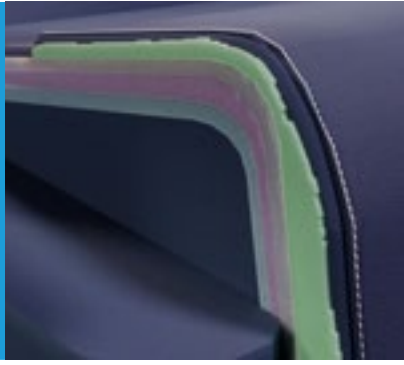

Encosto e pesseira  
articulado em sincronia



Encosto e assento  
anatômico



## RECURSOS PADRÕES

- Estrutura madeira de reflorestamento.
- Superfície de Courvin.



Braços acolchoados



Diversas opções de Courvin

## MOVIMENTOS



Dorso



Pernas



### DADOS TÉCNICOS

Posição Normal: Comp: ≈730mm;  
Largura: ≈760mm; Altura: 490mm;  
Estendida ≈1600mm.

[Clique aqui para acessar  
as opções de cores](#)





Acolchoado de espumas D28 e soft D28



Encosto e pesseira articulado em sincronia



Encosto e assento anatômico

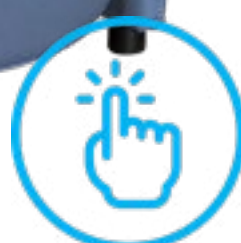

**RECURSOS PADRÕES**

- Estrutura madeira de reflorestamento.
- Superfície de Courvin.
- Articulação Manual.



Braços acolchoados

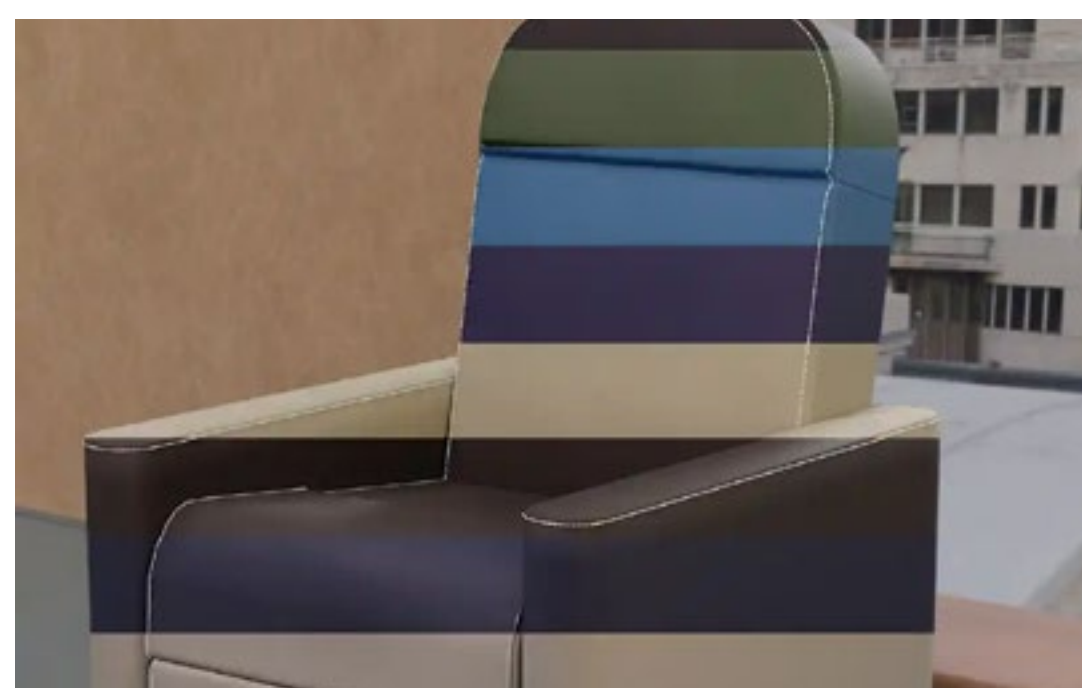

Diversas opções de Courvin

**MOVIMENTOS**



Dorso



Pernas



**DADOS TÉCNICOS**

Posição Normal: Comp: ≈750mm;  
Largura: ≈650mm; Altura: ≈460mm;  
Estendida ≈1520mm.

**Clique aqui para acessar as opções de cores**

VOLTAR PARA

**ÍNDICE**

## Diamond | MT 640



Acolchoado de espumas  
D28 e soft D28



Movimentos  
Independentes



Encosto e assento  
anatômico



### RECURSOS PADRÕES

- Estrutura MDF.
- Superfície de Courvin.



Braços acolchoados

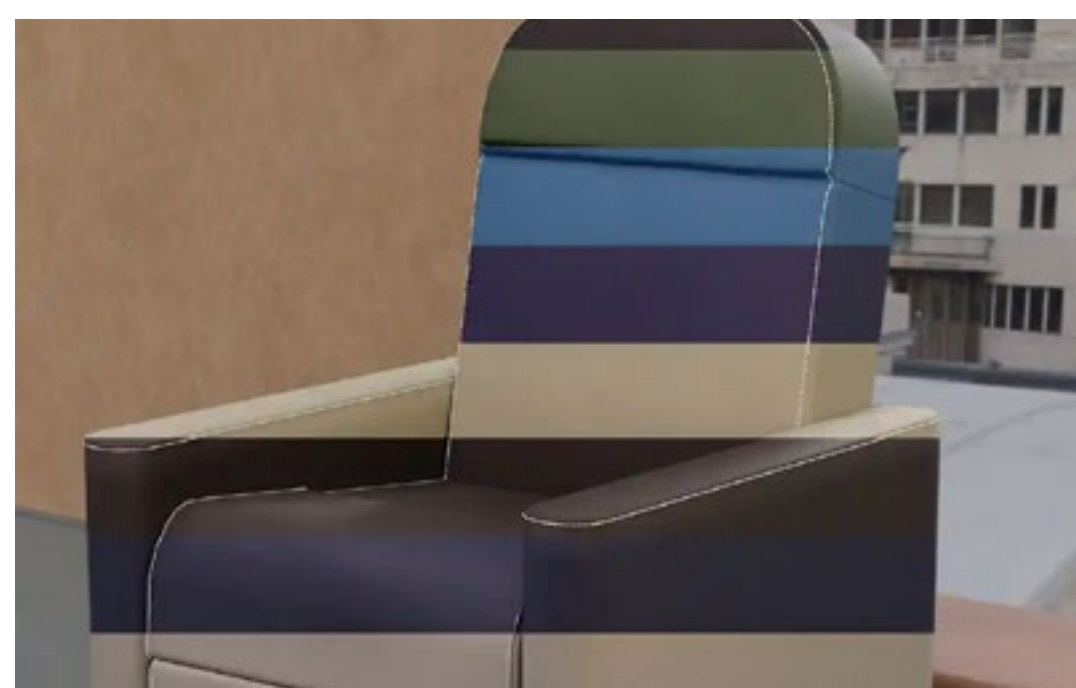

Diversas opções de Courvin

### MOVIMENTOS



Dorso



Pernas



#### DADOS TÉCNICOS

Posição Normal: Comp: ≈990mm;  
Largura: ≈650mm; Altura: ≈470mm;  
Estendida ≈1600mm.

[Clique aqui para acessar  
as opções de cores](#)



Suporte p/ mala de emergência



Controle remoto de mão



Encosto e assento anatômico



## RECURSOS PADRÕES

- Estrutura de aço carbono.
- Superfície de couro ecológico.
- Carenagem anti-ferrugem com escoamento de líquidos.
- Movimentos independentes.

- Rodas 4”.



## MOVIMENTOS



Dorso



Pernas



Trend



Proclive



Elevação mínima

520mm



Elevação máxima

720mm



### DADOS TÉCNICOS

Posição Normal: Comp: ≈1050 - 1200mm;  
Largura: ≈720mm; Altura: 520 - 720mm;  
Reclinada: Comp: ≈1800mm.

[Clique aqui para acessar as opções de cores](#)



Motorizado Encosto +  
peseira + elevação



Controle remoto de mão



Superfície de Couro  
Ecológico

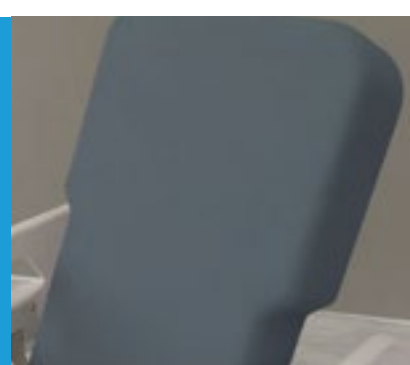

## RECURSOS PADRÕES

- Estrutura de aço carbono.
- Base de aço carbono.
- Roda de 4" com freio individual.
- Suporte p/ saco Foley.
- Suporte p/ Soro

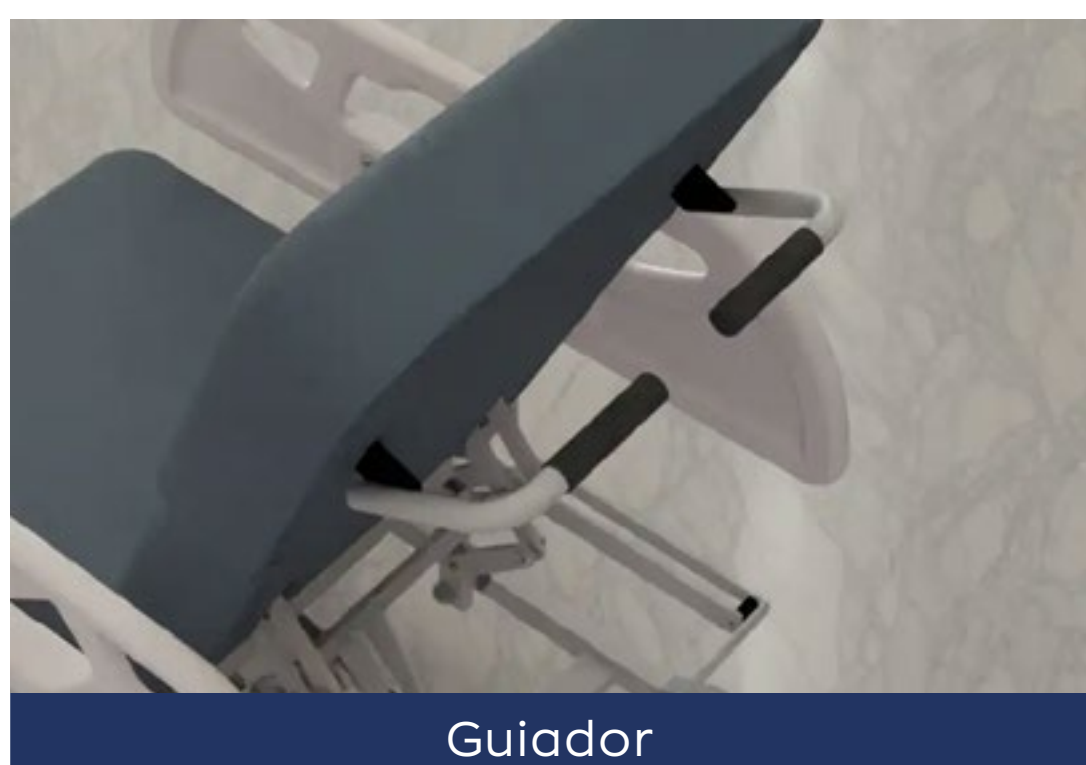

Guiador



Diversas opções de Courvin

## MOVIMENTOS



Fowler  
Dorso



Fowler  
Pernas



Elevação  
mínima

520mm



Elevação  
máxima

720mm



### DADOS TÉCNICOS

Posição Normal: Comp: 1050mm;  
Largura: 720mm; Altura: 520 - 720mm;  
Reclinada: Comp: ≈1800mm.

[Clique aqui para acessar  
as opções de cores](#)



Pés com proteção do piso



Alavancas para movimentação



Braços acolchoados



## RECURSOS PADRÕES

- Base de aço inox.
- Estofado D-28 e Soft D-28.



Movimentos independentes

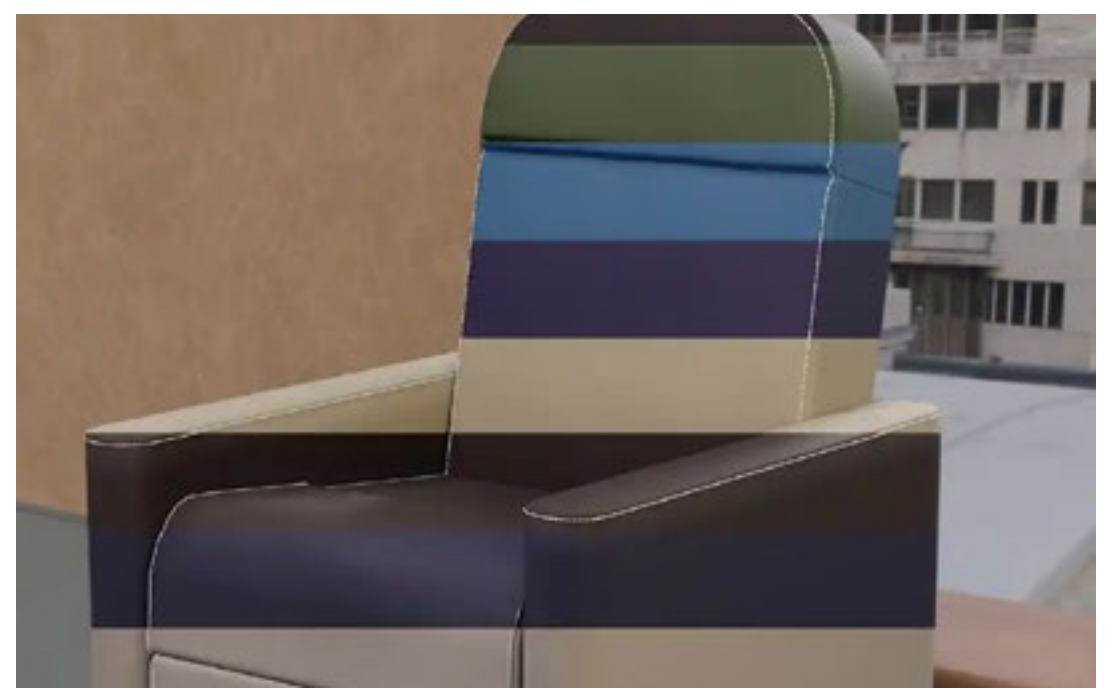

Diversas opções de Courvin

## MOVIMENTOS



Dorso



Pernas



### DADOS TÉCNICOS

Posição Normal: Comp: ≈870mm;  
Posição Reclinada: Comp: ≈1600mm;  
Largura: ≈790mm; Altura: ≈470mm.

[Clique aqui para acessar as opções de cores](#)

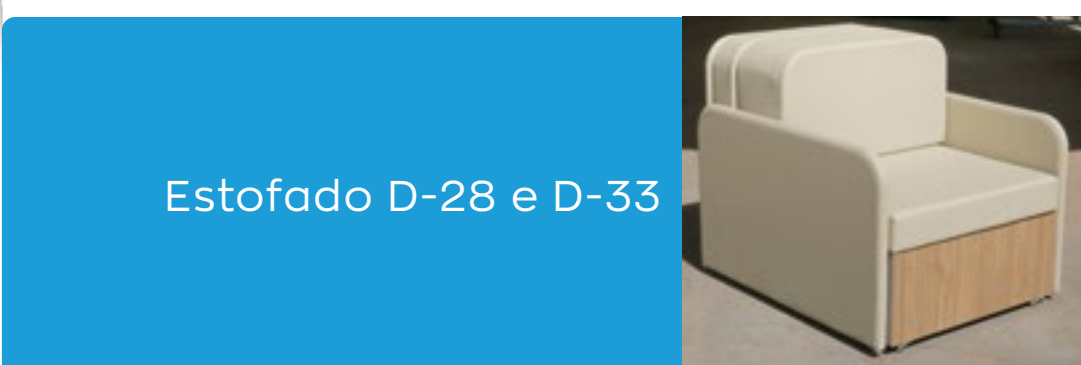

## RECURSOS PADRÕES

- Estrutura de madeira reflorestada.
- Superfície de couro ecológico.
- Assento retrátil para modo cama.

- Rodízio de 3”.



Modo cama

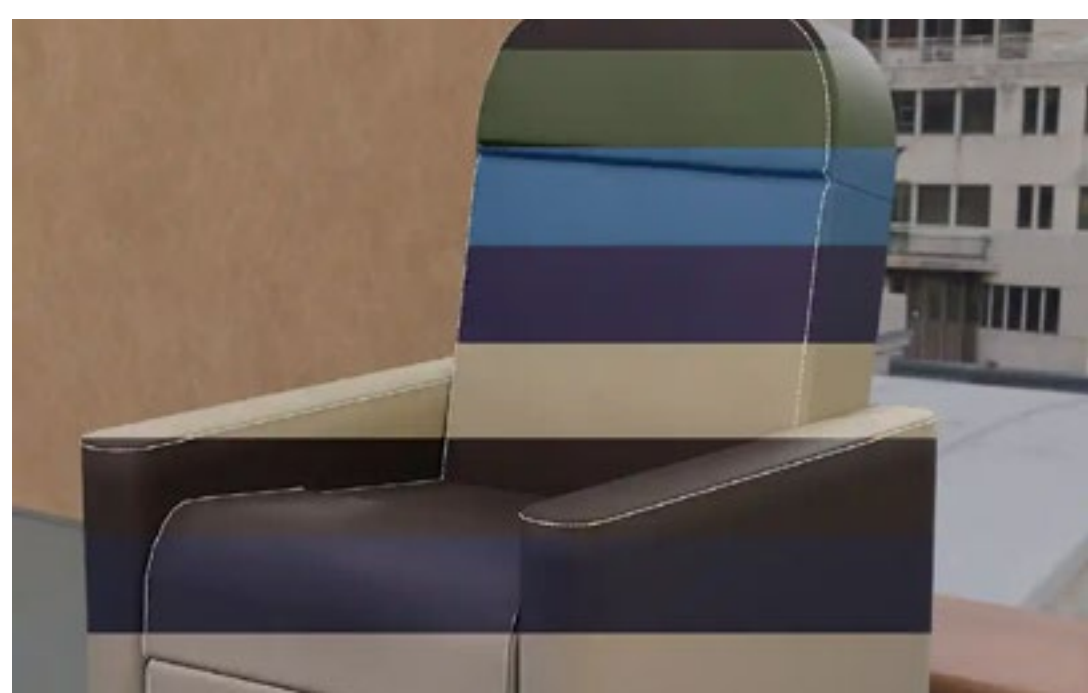

Diversas opções de Courvin



## DADOS TÉCNICOS

Posição Normal: Comp: ≈990mm;  
Posição Cama: Comp: ≈1800mm;  
Largura: ≈1825mm; Altura: ≈470mm.

[Clique aqui para acessar as opções de cores](#)



MESAS DE

**REFEIÇÃO**

## Mesa de Refeição Dual | MT 725



Base em aço carbono



Mesa em Madeira reflorestada



Se encaixa perfeitamente nas camas Metahospitalar



## RECURSOS PADRÕES

- Haste de aço carbono com pintura eletrostática.
- Regulagem de altura.
- 4 rodas de rodízio duplo com freio individual.



Base curva



Regulagem de altura



Freio individual



## DADOS TÉCNICOS

Total: Comp: 90mm;

Largura: 450mm; Altura: 700-1080mm.



## Mesa de Refeição Elevação | MT 724



Base em aço carbono

Mesa em Madeira  
reflorestadaSe encaixa perfeitamente  
nas camas Metahospitalar

## RECURSOS PADRÕES

- Haste de aço carbono com pintura eletrostática.
- Regulagem de altura.
- 4 rodas de rodízio duplo com freio individual.

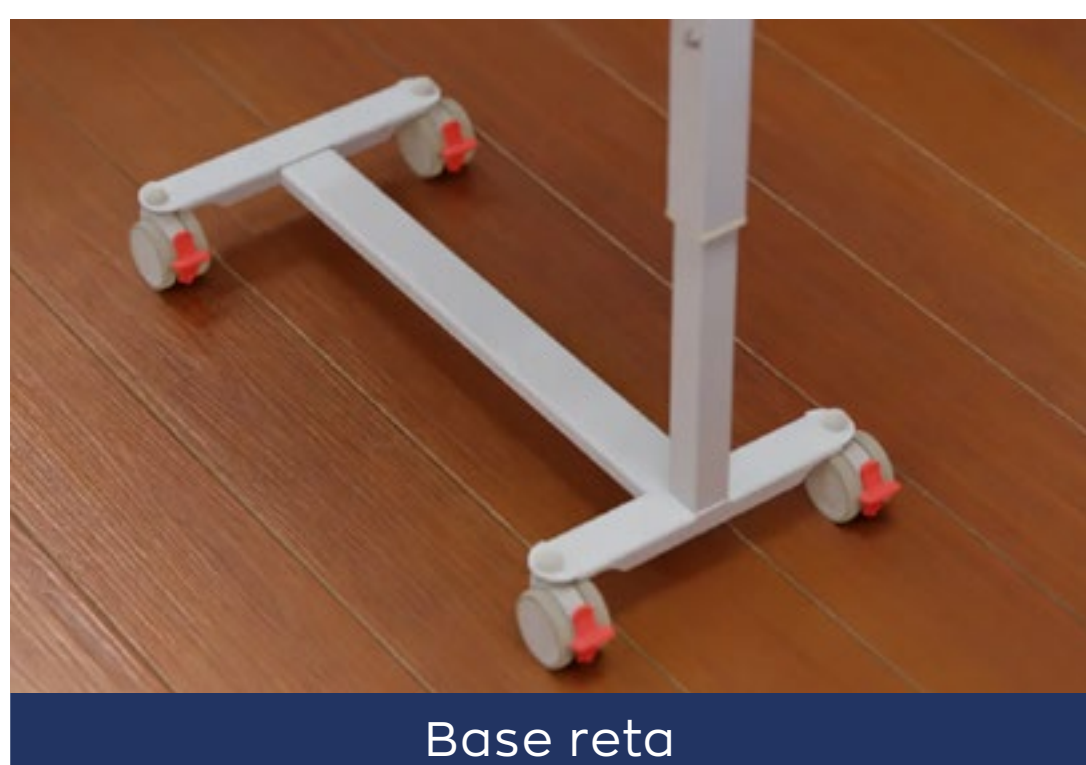

Base reta



Regulagem de altura



Freio individual



## DADOS TÉCNICOS

Total: Comp: 900mm;

Largura: 450mm; Altura: 700 - 1080mm.

## Mesa de Refeição Inox | MT 721



Base em aço inox

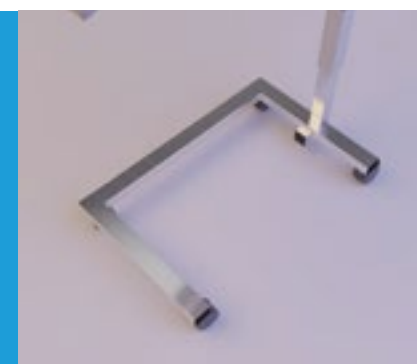

Mesa em termoplástico com suporte p/ copos

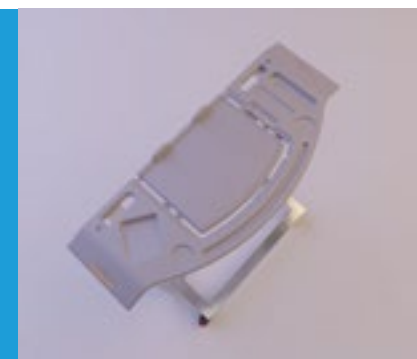

Se encaixa perfeitamente nas camas e mesas de cabeceira Metahospitalar



## RECURSOS PADRÕES

- Haste de aço carbono com pintura eletrostática.
- Puxador para destravamento e rebaixamento do tampo.
- 4 rodas de rodízio duplo com

freio diagonal.



Base em formato de U



Regulagem de altura



Bandeja retrátil



## DADOS TÉCNICOS

Total: Comp: 800mm;  
Largura: 330mm; Altura: 1080 - 930mm.



Base em aço carbono revestida com termoplástico



Mesa em termoplástico com suporte p/ copos



Se encaixa perfeitamente nas camas e mesas de cabeceira Metahospitalar



## RECURSOS PADRÕES

- Haste de aço carbono com pintura eletrostática.
- Puxador para destravamento e rebaixamento do tampo.
- 4 rodas de rodízio duplo com

freio diagonal.



Base em formato de U



Regulagem de altura



Bandeja retrátil



## DADOS TÉCNICOS

Total: Comp: 800mm;  
Largura: 330mm; Altura: 1080-930mm.



Fácil uso



Fundamental para ser usado em conjunto com toda a Linha de Camas Flex



Pode ser acondicionada na peseira da cama



## RECURSOS PADRÕES

- Otimiza o espaço.
- Praticidade na limpeza.
- Estrutura de termoplástico.



Porta copos



## DADOS TÉCNICOS

Produto desenvolvido para encaixe perfeito nas grades das camas Flex.



Fácil uso

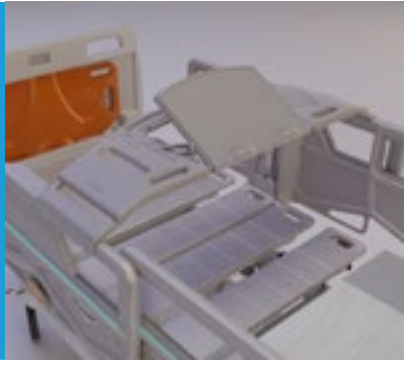

Fundamental para ser usado em conjunto com toda a Linha de Camas Diamond



Pode ser acondicionada no interior da peseira da cama



## RECURSOS PADRÕES

- Otimiza o espaço.
- Praticidade na limpeza.
- Estrutura de termoplástico.



Porta copos, pratos e livros



## DADOS TÉCNICOS

Produto desenvolvido para encaixe perfeito nas grades das camas Diamond.



MESAS DE

**CABECEIRA**

## Lista de Opcionais:

CL 35



CL 39



CL 36



CL 40



CL 37



CL 41

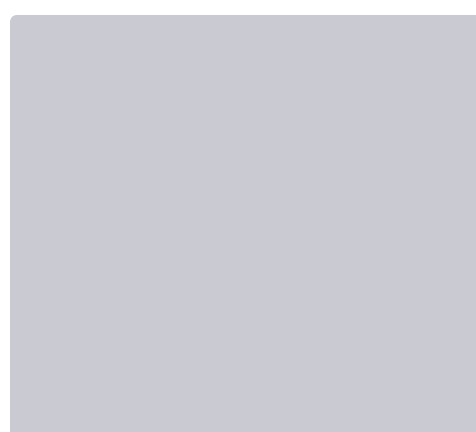

CL 38



CL 42



MDF



Puxadores em alumínio

Protetor de parede na base

Nicho com revestimento especial

### RECURSOS PADRÕES

- Estrutura em MDF de 15 mm.
- 4 rodízios duplos com proteção anti risco com freio.
- Protetor de parede na base.
- Gaveta com corrediças

telescópicas.

- Dobradiças com fechamento suave.

CL 40 E CL 39



Revestimento em cores diversas



### DADOS TÉCNICOS

Total: Comp: 490mm;  
Largura: 515mm; Altura:825mm.

[Clique aqui para acessar as opções de cores](#)





Puxadores embutidos

Protetor de parede na base

Tampo removível em termoplástico



### RECURSOS PADRÕES

- Estrutura em MDF de 15 mm.
- 4 rodízios duplos com proteção anti risco com freio.
- Gaveta com corrediças telescópicas.

- Dobradiças com fechamento suave.

CL 40 E CL 41



Revestimento em cores diversas



### DADOS TÉCNICOS

Total: Comp: 490mm;  
Largura: 515mm; Altura: 825mm.

[Clique aqui para acessar as opções de cores](#)



Puxadores em alumínio

Protetor de parede na base

Tampo removível em termoplástico



## RECURSOS PADRÕES

- Estrutura em MDF de 15 mm.
- 4 rodízios duplos com proteção anti risco com freio.
- Protetor de parede na base.
- Gaveta com corrediças

telescópicas.

- Dobradiças com fechamento suave.

CL 38 E CL 39



Revestimento em cores diversas



## DADOS TÉCNICOS

Total: Comp: 465mm;  
Largura: 415mm; Altura: 940mm.

[Clique aqui para acessar as opções de cores](#)



ACESSÓRIOS



5 saídas de gases diversos  
com luz noturna

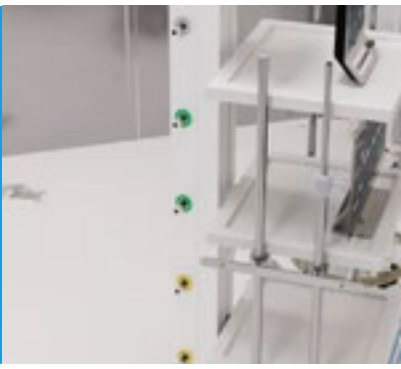

Tomada com led para  
conexão de fase tomadas  
110v e 220v



Suporte p/ aparelhos em  
aço inox



## RECURSOS PADRÕES

- Estrutura em aço carbono
- Tubo de condutores de cabo.
- Ancoragem em termoplástico.
- Coluna com regulagem de altura das bandejas.
- Interruptores para luz da estativa e leito.
- Suporte de soro com regulagem e 4 hastes de fixação.



Rolamento com giro de 120°



Gavetas com corrediças telescópicas



Duas bandejas modulares e uma fixa



## DADOS TÉCNICOS

Total: Comp: ≈630mm;  
Largura: ≈610mm; Altura: ≈1800 - 2800mm.



Mais mobilidade e acessibilidade a todos os aparelhos dentro de um leito hospitalar

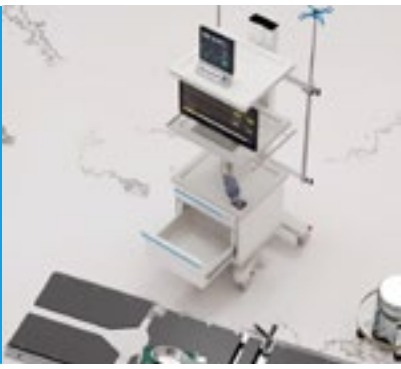

Parte interna em termoplástico removíveis



Suporte p/ aparelhos em aço inox



## RECURSOS PADRÕES

- Estrutura em aço carbono
- Bandejas removíveis.
- Rodas de 4”.
- Coluna com regulagem de altura das bandejas.

- Duas gavetas.
- Suporte de soro com regulagem e 2 hastes de fixação.



Freio individual



Gavetas com corrediças telescópicas



Dois bandejas modulares e uma fixa



## DADOS TÉCNICOS

Total: Comp: ≈640mm;  
Largura: ≈740mm; Altura: ≈1630mm.



Suporte p/ Cilindro de Oxigênio



Régua de Energia



Suporte p/ Aparelhos com Regulagem de Altura



## RECURSOS PADRÕES

- Estrutura em aço carbono.
- Bandejas das gavetas removíveis.
- Rodas de 4" com proteção ao piso com baixo ruído.

- Freio individual nas quatro rodas.



Suporte p/ Soro



Gavetas com corrediças telescópicas



Tábua de massagem cardíaca



## DADOS TÉCNICOS

Total: Comp: ≈460mm;  
Largura: ≈770mm; Altura: ≈1000mm.



Suporte p/ Notebook



Gavetas em termoplástico removível



Freio individual



## RECURSOS PADRÕES

- Estrutura em aço carbono.
- Bandejas das gavetas removíveis.
- Rodas de 4" com proteção ao piso com baixo ruído.



Suporte p/ descarpack



Gavetas com corrediças telescópicas



Gavetas com divisórias



### DADOS TÉCNICOS

Total: Comp: ≈460mm;  
Largura: ≈670mm; Altura: ≈1050mm.

\*Imagem meramente ilustrativa. Notebook, suporte de notebook e descarpack não estão inclusos.



Tampo em termoplástico



Gavetas em termoplástico removível



Freio individual



## RECURSOS PADRÕES

- Estrutura em aço carbono.
- Bandejas das gavetas removíveis.
- Rodas de 4" com proteção ao piso com baixo ruído.



Suporte p/ descarpack

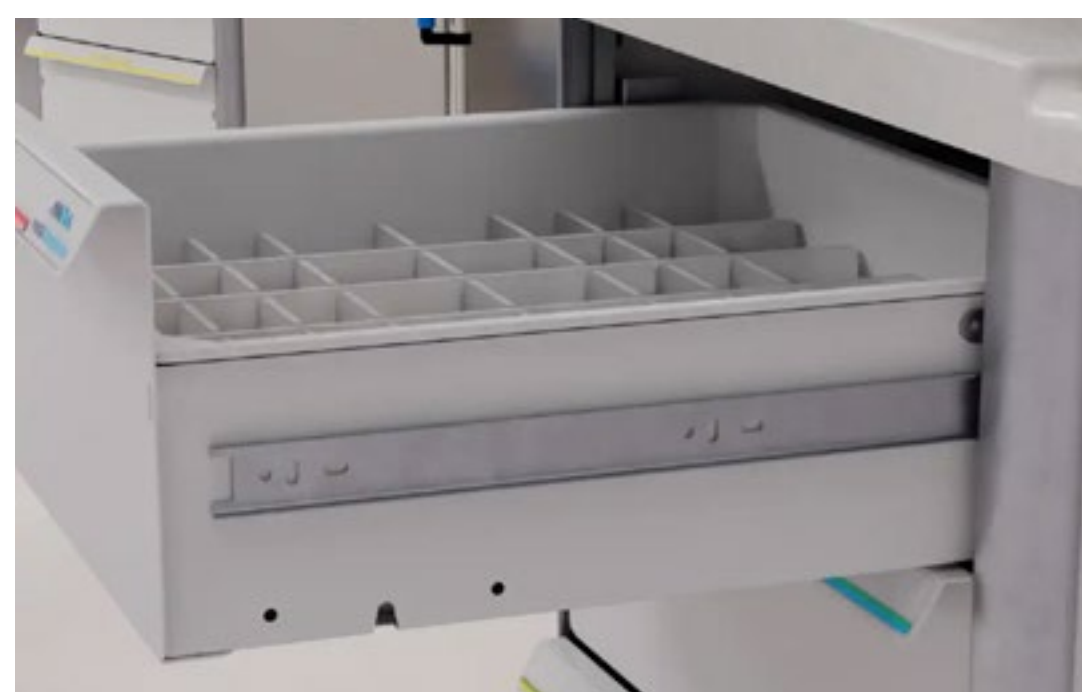

Gavetas com corrediças telescópicas



Gavetas com divisórias



## DADOS TÉCNICOS

Total: Comp: ≈460mm;  
Largura: ≈670mm; Altura: ≈1050mm.





Tampo em aço inox



Pés em termoplástico



Suporte p/ Notebook



## RECURSOS PADRÕES

- Estrutura em aço carbono.
- Rodas de 4".
- Freio Individual.

Accessórios



Suporte p/ descarpac

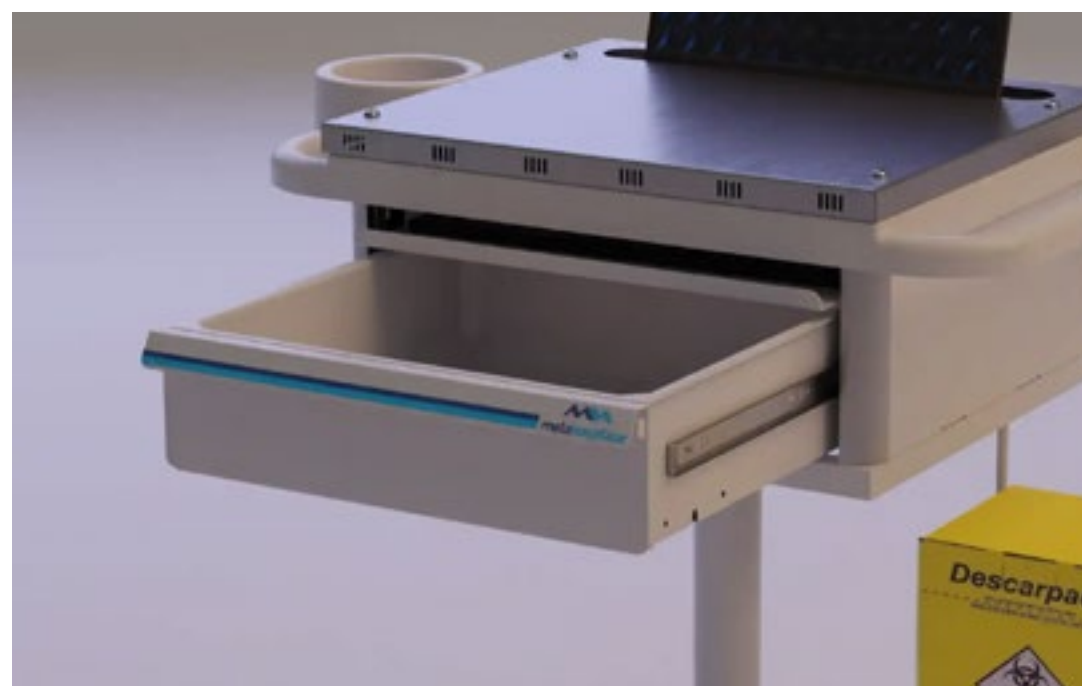

Gaveta com corrediças telescópicas



Gaveta p/ teclado



### DADOS TÉCNICOS

Total: Comp: ≈770mm;  
Largura: ≈460mm; Altura: ≈860mm.

\*Imagem meramente ilustrativa. Notebook, suporte de notebook e descarpac não estão inclusos.

# Suporte para Soro | MT 931 e MT 933



Regulagem de altura



Pés em termoplástico



Estrutura em aço inox



2 hastes inferiores p/  
suporte de coletor de  
urina



Pés em termoplástico



Design com suporte para  
auxiliar na caminhada  
do paciente e apoio para  
cuba rim

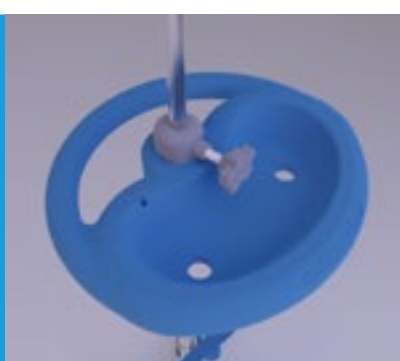

## RECURSOS PADRÕES

- Estrutura em aço inox.
- Base em termoplástico.
- 5 rodízios duplos com proteção anti risco.
- 4 hastes retráteis com

regulagem de altura.



### DADOS TÉCNICOS

Total: Comp: ≈540mm;  
Largura: ≈540mm; Altura: ≈1300 - 2300mm.

## Colchão Hospitalar



Laminado - MT 672

MT 210, MT 212, MT 215, MT 160,  
MT 165, MT 149, MT 152, MT 155.

**DADOS TÉCNICOS**

Total: Comp: 1950mm;  
Largura: 830mm; Altura: 120mm.



Colméia - MT 660

MT 160, MT 165, MT 149, MT 152,  
MT 155.

**DADOS TÉCNICOS**

Total: Comp: 1950mm;  
Largura: 830mm; Altura: 120mm.



Visco Elástico - MT 666

MT 210, MT 212, MT 215, MT 160,  
MT 165, MT 149, MT 152, MT 155.

**DADOS TÉCNICOS**

Total: Comp: 1950mm;  
Largura: 830mm; Altura: 120mm.

**RECURSOS PADRÕES**

- Revestimento Courvin Pevecron impermeável que não retém poeira e possui fácil limpeza e assepsia.
- Espuma de poliuretano

laminada de densidade D-28, proporcionando maior conforto.

- Acompanha todos os movimentos das camas elétricas



CME



Suporte p/ luminária circular



Suporte p/ embalagem em rolo



Estante com 2 prateleiras de aço carbono



## RECURSOS PADRÕES

- Estrutura em aço carbono.
- 2 Gaveteiros.
- Possibilidade de led na parte superior.
- Elevação.

- Rodas de 4" com freio nas 4 rodas.
- Base de TS.



Suporte articulado para monitor



Suporte p/ teclado



Suporte p/ nobreak



## DADOS TÉCNICOS

Total: Comp: ≈1600mm;  
Largura: ≈700mm; Altura: ≈700 - 1350mm.



Arestas arredondadas



Fácil assepsia



Resistente a produtos de limpeza e desinfecção



## RECURSOS PADRÕES

- Estrutura chapa de inox.
- Rodas giratórias de 3”.



### DADOS TÉCNICOS

Total: Comp: 1650mm;  
Largura: 800mm; Altura: 900mm.



Alça de Transporte



Freio individual



Prateleira Interna



## RECURSOS PADRÕES

- Construído em Chapa de Aço Inoxidável.
- Provido de duas portas com Sistema de Fechamento por Trava.

- Roda de 4" giratórias.



### DADOS TÉCNICOS

Total: Comp: 1110mm;  
Largura: 500mm; Altura: 1140mm.



Alça de Transporte

Freio individual

Prateleira Interna

## RECURSOS PADRÕES

- Construído em Chapa de Aço Inoxidável.
- Provido de duas portas com Sistema de Fechamento por Trava.

- Roda de 4" giratórias.



### DADOS TÉCNICOS

Total: Comp: 1110mm;  
Largura: 500mm; Altura: 1140mm.





Prateleiras



Alça de Transporte



Protetor de parede



### RECURSOS PADRÕES

- Estrutura em aço inoxidável.
- Rodas giratórias de 3”.
- Freio diagonal.



#### DADOS TÉCNICOS

Total: Comp: 740mm;

Largura: 530mm; Altura: 995mm.



Grampos de rolo



Alça de Transporte



Freio individual em 2 rodas



## RECURSOS PADRÕES

- Estrutura em aço inoxidável.
- Rodas giratórias de 3”.



### DADOS TÉCNICOS

Total: Comp: 950mm;

Largura: 700mm; Altura: 940mm.



Alça de Transporte



Freio individual



Válvula para Escoamento  
de Líquidos



## RECURSOS PADRÕES

- Totalmente Construído em Chapa de Aço Inoxidável.
- Pés de roda de 3" giratórias.



### DADOS TÉCNICOS

Total: Comp: 740mm;  
Largura: 540mm; Altura: 890mm.

## Estante para Cestas | MT 520

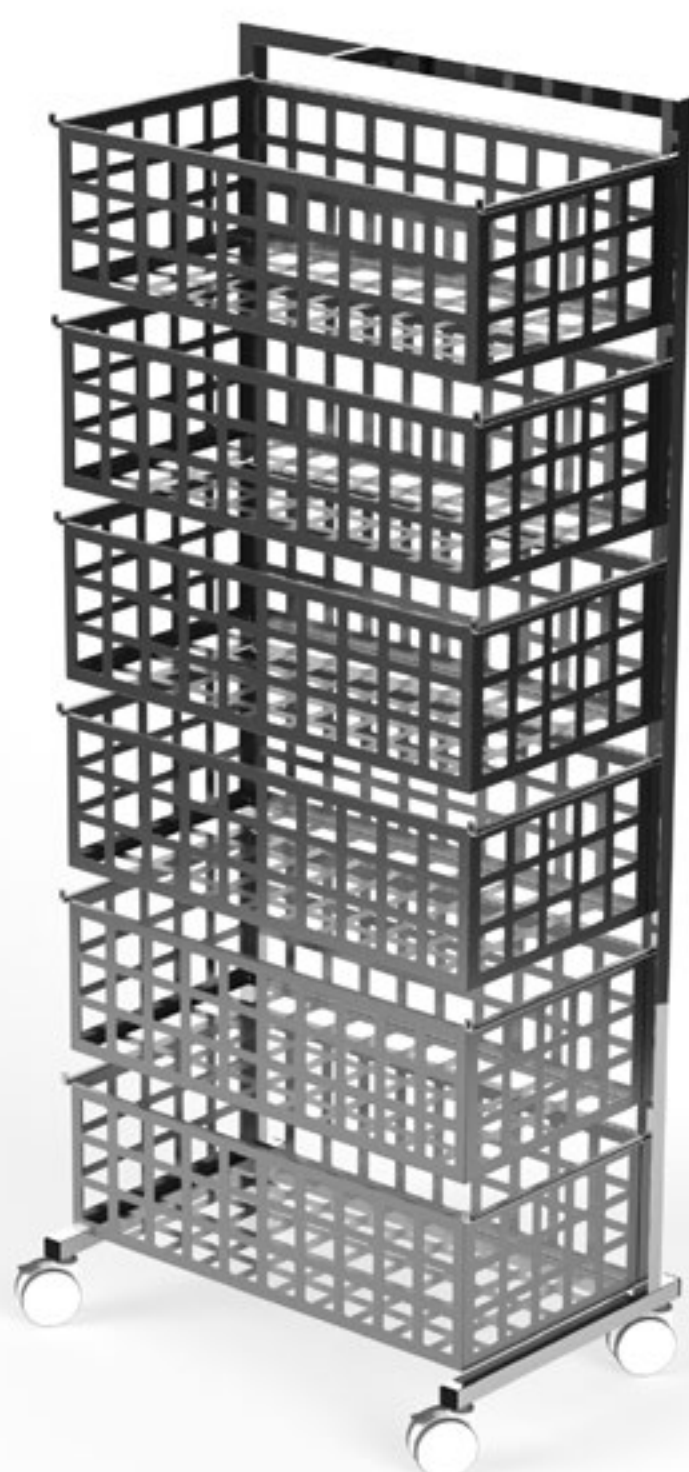

6 suportes



6 cestas

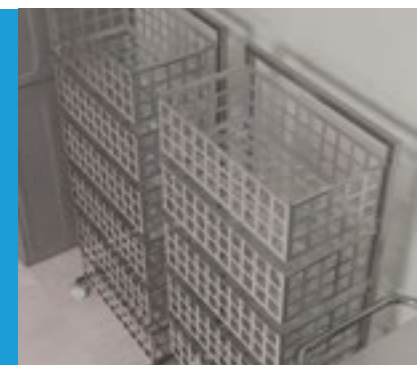

Fácil assepsia



## RECURSOS PADRÕES

- Estrutura aço Inoxidável.
- Armazenamento de substâncias sensíveis ou produtos refrigerados, em hospitais ou qualquer tipo de indústria.



## DADOS TÉCNICOS

Total: Comp: ≈670mm;  
Largura: ≈430mm; Altura: ≈1580mm.



4 prateleiras



Fácil assepsia



Resistente a produtos de limpeza e desinfecção



### RECURSOS PADRÕES

- Estrutura aço Inoxidável.
- Armazenamento de substâncias sensíveis ou produtos refrigerados, em hospitais ou qualquer tipo de indústria.



### DADOS TÉCNICOS

Total: Comp: ≈1200mm;  
Largura: ≈500mm; Altura: ≈1580mm.



**CORPORATIVO**



Encosto baixo



Regulagem de altura de assento com pistão a gás



Revestimento sintético de qualidade



Encosto Alto



Regulagem de altura de assento com pistão a gás



Revestimento Sintético de qualidade



## RECURSOS PADRÕES

- Encosto e assento revestidos com espuma injetável.
- Mecanismo Back System que permite total regulagem de assento e encosto.



**DADOS TÉCNICOS MT 820**  
Total: Comp: 540mm;  
Largura: 580mm;  
Altura: 910 - 1000mm.

**DADOS TÉCNICOS MT 821**  
Total: Comp: 650mm;  
Largura: 615mm;  
Altura: 950 - 1080mm.





Resistente, ergonômica e ajustável



Disponível em 7 diferentes cores de polipropileno



Mais de 45 cores de revestimento de assento



### RECURSOS PADRÕES

- Base piramidal em nýlon com aditivo de fibra de vidro.
- Perfeita para o home, ideal para o Office.
- Inclinação do conjunto

assento e encosto de forma sincronizada.



### DADOS TÉCNICOS

Total: Comp: 730mm;  
Largura: 730mm; Altura: 410 - 510mm.



# Cadeira Up | MT 810, MT 811 E MT 812



Expressa modernidade e bom gosto



Ergonômica



Empilhável



## RECURSOS PADRÕES

- Assento e encosto injetados em polipropileno 100% reciclável.



### DADOS TÉCNICOS

Total: Comp: 545mm;  
Largura: 575mm; Altura: 785mm.



Assentos para ambientes multifuncionais



Disponível em diversas cores



Fácil empilhamento



Acento acolchoado



Disponível em diversas cores



Fácil empilhamento



## RECURSOS PADRÕES

- Contra assento e encosto injetados em polipropileno.



DADOS TÉCNICOS MT 820  
Total: Comp: 550mm;  
Largura: 555mm; Altura: 810mm.



2 lugares



#### DADOS TÉCNICOS MT 815

Total: Comp: 1020mm;  
Largura: 590mm.

3 Lugares



#### DADOS TÉCNICOS MT 816

Total: Comp: 1540mm;  
Largura: 590mm.



4 Lugares



#### DADOS TÉCNICOS MT 817

Total: Comp: 2060mm;  
Largura: 590mm.

### RECURSOS PADRÕES

- Para recepção, assento de espera.



Design minimalista



## RECURSOS PADRÕES

- Assento em termoplástico.





Design minimalista



## RECURSOS PADRÕES

- Assento em termoplástico.



## DADOS TÉCNICOS

Total: Comp: 420mm;  
Largura: 420mm; Altura: 870mm.



## RECURSOS PADRÕES

- Poltrona de recepção.



**DADOS TÉCNICOS**  
Total: Comp: 645mm;  
Largura: 670mm;  
Altura: 450mm.

**Clique aqui para acessar  
as opções de cores**



## RECURSOS PADRÕES

- Sofá em courvin 2 lugares.



**DADOS TÉCNICOS**  
Total: Comp: 1170mm;  
Largura: 670mm;  
Altura: 450mm.

[Clique aqui para acessar as opções de cores](#)



MT 840

**DADOS TÉCNICOS**

Ø: 600mm;  
Altura: 1040mm.



MT 841

**DADOS TÉCNICOS**

Ø: 600mm;  
Altura: 740mm.



MT 842

**DADOS TÉCNICOS**

Ø: 900mm;  
Altura: 740mm.



MT 843

**DADOS TÉCNICOS**

Ø: 750mm;  
Altura: 390mm.



MT 844

**DADOS TÉCNICOS**

Ø: 600mm;  
Altura: 390mm.





Com regulagem de altura  
para trabalho em pé



Resistente



Superfície em TS



## RECURSOS PADRÕES

- Estrutura em aço carbono.



### DADOS TÉCNICOS

Total: Comp: 1600mm;  
Largura: 700mm; Altura: 700 - 1100mm.

## RISCO DE QUEDA

Detecta sinais precoces de risco de queda, permitindo uma intervenção rápida para prevenir acidentes



## MÓDULO DE ENGENHARIA CLÍNICA

Oferece suporte técnico e manutenção para garantir o funcionamento contínuo e confiável do sistema



## FREQUÊNCIA CARDÍACA E RESPIRATÓRIA

Monitora continuamente a frequência cardíaca. Registra a frequência respiratória



## TRANSFORME SEU HOSPITAL COM TECNOLOGIA DE PONTA

Auxilia a equipe de enfermagem e engenharia. Economiza tempo e recursos

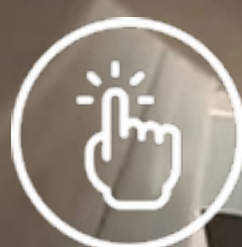

## CONETIVIDADE DE LEITOS HOSPITALARES

Flexível e adaptável, o BED Monitor pode ser instalado na central de enfermagem para acesso imediato ou conectado remotamente a dispositivos móveis, como smartphones e tablets, permitindo que os profissionais de saúde monitorem os pacientes de qualquer lugar.

Com o BED Monitor, sua equipe pode oferecer cuidados mais eficazes e personalizados, garantindo a segurança e o bem-estar de cada paciente.



ATÉ

# 90

DADOS DE INFORMAÇÕES

**Assistencial**

- RISCO DE QUEDA
- Grades
- Freio
- Altura Mínima
- Altura Máxima
- Trend
- Proclive
- Dorso
- Perna
- Intenção de

saída

- Paciente no leito
- Peso
- Iluminação
- Chamada de Enfermagem
- Tempo de decúbito
- Sobrepeso no leito

**Assistencial**

**EXCLUSIVO NOVO**

- FREQUENCIA CARDÍACA
- FREQUENCIA RESPIRATÓRIA
- AGITAÇÃO NO LEITO

**Engenharia**

- Cama Ligada na tomada
- Bateria fraca
- Sobrecorrente dos motores
- Paineis
- Balança
- Caixa de comando
- Ciclos dos motores
- Tempo de uso

\*Camas especiais

- Ciclos e tempo de uso dos motores de movimento transversal
- Ciclos e tempo de uso do motor peseria
- Ciclos e tempo de uso do motor extensor

Transforma uma cama hospitalar comum, em uma Cyber Bed. Ele é um dispositivo de última geração que integra hardware e software para fornecer uma experiência de cuidado totalmente nova e aprimorada.

O BedMonitor pode ser instalado em diversas infraestruturas dentre ela: Rede local e Nuvem. Além disso ele pode estar integrado a outros softwares de monitoramento.

## Modelos de camas disponíveis com CYBER BED.

**MT 231 - DIAMOND INTENSIVE CARE**  
Poltrona Cardíaca



**90**  
DADOS



**MT 233 - DIAMOND INTENSIVE CARE**  
Movimento Transversal



**84**  
DADOS



**MT 215 - DIAMOND INTENSIVE CARE**  
300 Kg



**78**  
DADOS



**MT 212 - DIAMOND INTENSIVE CARE**  
Rota de fuga



**78**  
DADOS



**MT 210 - DIAMOND CARE**



**75**  
DADOS



**MT 165 - EVOLUTION CARE**



**75**  
DADOS



O BedMonitor pode ser instalado em diversas infraestruturas dentre ela: Rede local e Nuvem. Além disso ele pode estar integrado a outros softwares de monitoramento.

**REQUISITOS MÍNIMOS DO SERVIDOR**

- Processador i7 11ª Geração ou superior
- 16Gb de Memória RAM
- SSD 512Gb de armazenamento

**REQUISITOS MÍNIMOS DA ESTAÇÃO DE MONITORAMENTO**

- Processador i5 11ª geração ou superior
- 8Gb de Memória RAM
- SSD 256Gb de armazenamento
- Monitor de 19" widescreen ou superior



CATÁLOGO

**NICOVIDA**

# NICOVIDA

*medical care*

## CAMAS

- CAMA MOTORIZADA VIDACARE - ND 1150
- CAMA VIDACARE 4 MOVIMENTOS - ND 1142
- CAMA VIDACARE - ND 1133
- CAMA VIDACARE 2 MOVIMENTOS - ND 1101

## CARROS MACA

- MACA CONCEITO - ND 1402
- MACA INOX - ND 1401



## BERÇOS

- BERÇO FOWLER - ND 1301 | ND 1302

## MESAS PARA EXAME

- MESA PARA EXAME - ND 1808 | ND 1809
- MESA PARA EXAME - ND 1806
- MESA GINECOLÓGICA - ND 1805
- MESA PARA EXAME CLÍNICO - ND 1804

## POLTRONAS

- POLTRONA SOFT - ND 1623 | ND 1624

## SOFÁS

- SOFÁ CAMA CONFORTAFÁCIL - ND 1602

## MESAS DE CABECEIRA E REFEIÇÃO

- MESA DE REFEIÇÃO - ND 1720
- MESA DE CABECEIRA - ND 1701



## ACESSÓRIOS

• MESAS AUXILIARES - ND 1900 | ND 1901 | ND 1902 | ND 1903

• MESA INSTRUMENTAL - ND 1905

• CARRO CURATIVO - ND 1907

• MESA DE MAYO - ND 1921

• BRAÇADEIRA PARA INJEÇÃO - ND 1930

• SUPORTE PARA SORO INOX - ND 1932

• BALDE A CHUTE - ND 1941 | ND 1942 | ND 1943

• ESCADINHA O2 DEGRAUS - ND 1950

• BANCO MOCHO - ND 1962

• BANCO MOCHO ENCOSTO - ND 1963

• HAMPER INOX - ND 1970

## COLCHÕES

• COLCHÃO - ND 1652 | ND 1672

## Toda linha de camas Nicovida possui:



**Freio Diagonal**



**Grades com trava**



**Tratamento antiferrugem**



**Sup. p/ bolsa de líquidos**



**Pintura eletrostática**



**Rodízio duplo**

## Lista de Opcionais:

**Raio X**  
ACO 91



**Colchão**

ND 1672  
ND 1652

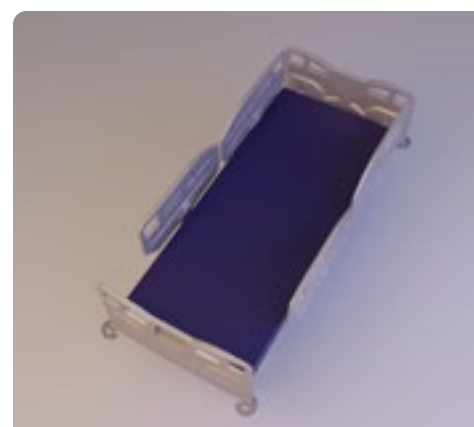

**Rodas e Freio**

ACO 04 - Freio Diagonal 4"  
ACO 05 - Freio Individual 4"  
ACO 06 - 6"

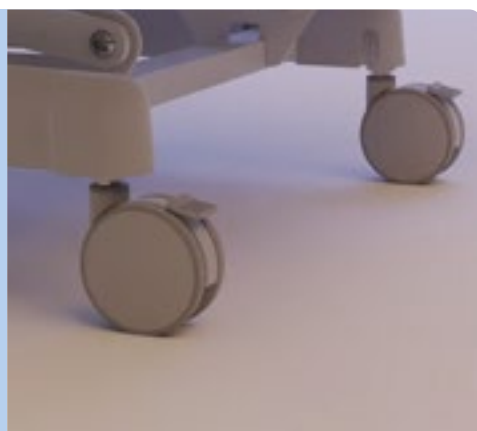

**Personalizações**

ACO 40 - Grades  
ACO 41 - Peseira/Cabeceira



**Carenagem**  
ACO 31



**Suporte p/ Soro**  
ND 1935



**Digital**

ACO 61 - Lado Direito  
ACO 62 - Completo  
ACO 63 - Supervisor s/ Display



**Protetor de Parede**  
ACO 30



ACO 79  
**Bateria**



ACO 23  
**Suporte p/ oxigênio**



Freio Diagonal



Controle Remoto



Carenagem Parcial



280Kg



## RECURSOS PADRÕES

- Peseira e Cabeceira removíveis.
- Elevação motorizada.
- Descanso de perna elétrico.
- Grades com rota de fuga.



Leito em aço carbono



Rodas duplas de 4"

## MOVIMENTOS DO LEITO



Fowler Dorso

0 - 77°



Fowler Pernas

0° - 23°



Trend

-15°



Procline

+15°



Elevação mínima

330mm



Elevação máxima

680mm



Posição Poltrona



### DADOS TÉCNICOS

Leito: Comp: 1950mm; Largura: 830mm;  
Total: Comp: 2180mm com extensor;  
Largura: 1000mm; Altura: 330 - 680mm.

[Clique para ver a lista de opcionais](#)

**OPCIONAIS**



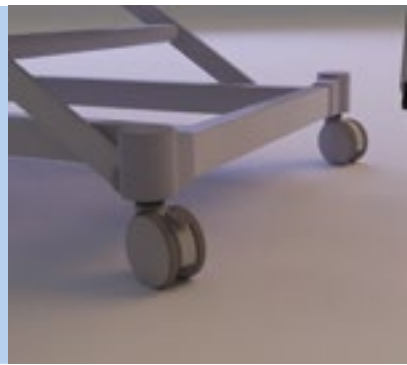
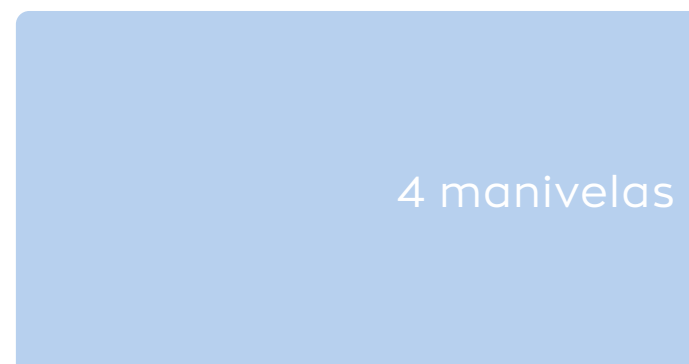

### RECURSOS PADRÕES

- Peseira e Cabeceira removíveis.
- Movimentos através de sistema mecânico de fácil manuseio.
- 4 manivelas para movimentos, dorso, pernas, elevação, proclive

e trendelenburg.



Leito em aço carbono



Rodas duplas de 4"

### MOVIMENTOS DO LEITO

Fowler Dorso	Fowler Pernas	Trend	Proclive	Elevação mínima	Elevação máxima	Posição Poltrona
0 - 77°	0° - 23°	-15°	+ 15°	440mm	750mm	



#### DADOS TÉCNICOS

Leito: Comp: 1950mm; Largura: 830mm;  
Total: Comp: 2270mm com extensor;  
Largura: 1000mm; Altura: 440 - 750mm.

Clique para ver a lista de opcionais

**OPCIONAIS**



Freio Diagonal



Carenagem Parcial



3 manivelas



180Kg



## RECURSOS PADRÕES

- Peseira e Cabeceira removíveis.
- Movimentos através de sistema mecânico de fácil manuseio.
- 3 manivelas para movimentos, dorso, pernas e elevação.



Leito em aço carbono



Rodas duplas de 4"

## MOVIMENTOS DO LEITO



Fowler  
Dorso

0 - 75°



Fowler  
Pernas

0° - 27°



Elevação  
mínima

400mm



Elevação  
máxima

620mm



### DADOS TÉCNICOS

Leito: Comp: 1900mm; Largura: 800mm;  
Total: Comp: 2160mm com extensor;  
Largura: 920mm; Altura: 340 - 690mm.

Clique para ver a lista de opcionais

**OPCIONAIS**



Freio Diagonal

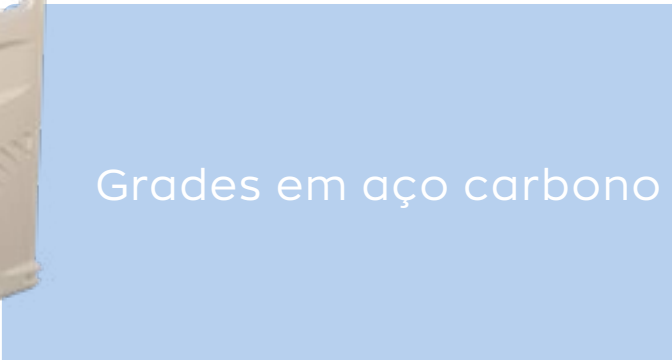
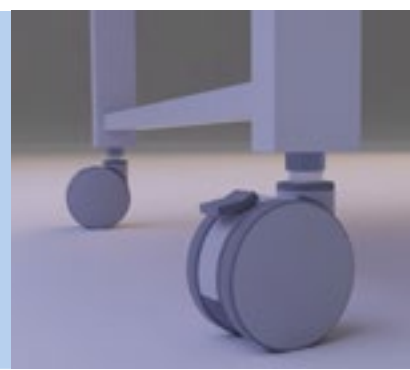

Grades em aço carbono

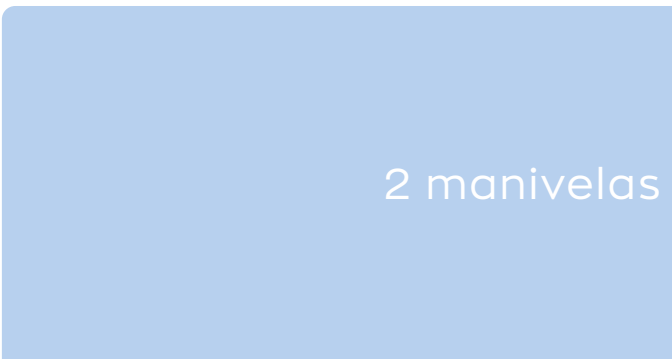

2 manivelas



### RECURSOS PADRÕES

- Peseira e Cabeceira removíveis.
- Movimentos através de sistema mecânico de fácil manuseio.
- 2 manivelas para movimentos, dorso e pernas.



Leito em aço carbono

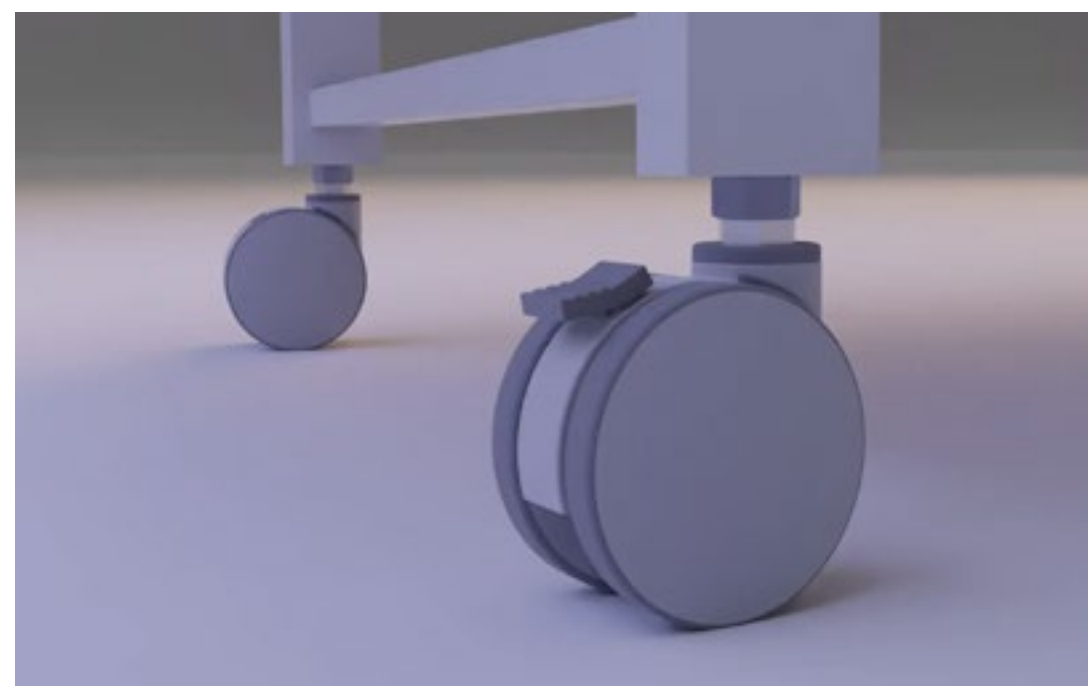

Rodas duplas de 3"

### MOVIMENTOS DO LEITO



Fowler Dorso

0 - 75°



Fowler Pernas

0° - 27°



#### DADOS TÉCNICOS

Leito: Comp: 1900mm; Largura: 800mm;  
Total: Comp: 2160mm com extensor;  
Largura: 880mm; Altura: 620mm.

Clique para ver a lista de opcionais

**OPCIONAIS**



Freio individual



Elevação do leito através de manivela

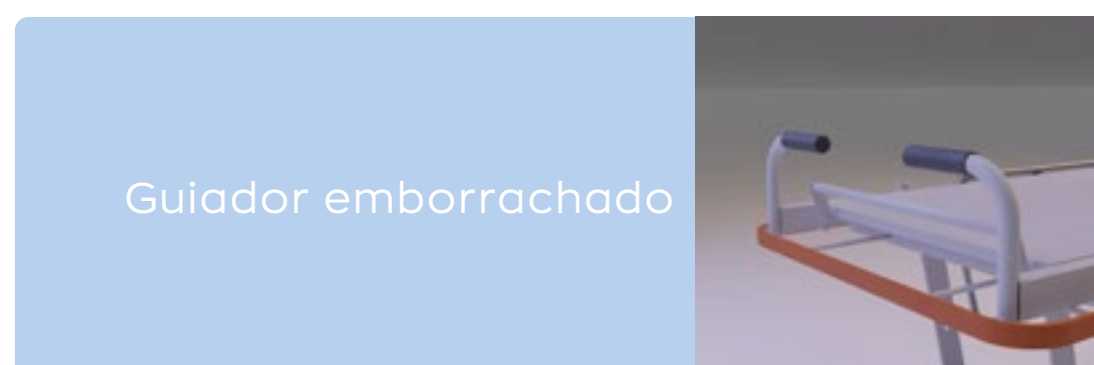

Guiador emborrachado

## RECURSOS PADRÕES

- Grades em aço inox.
- Dorso com sistema de regulagem por cremalheira.

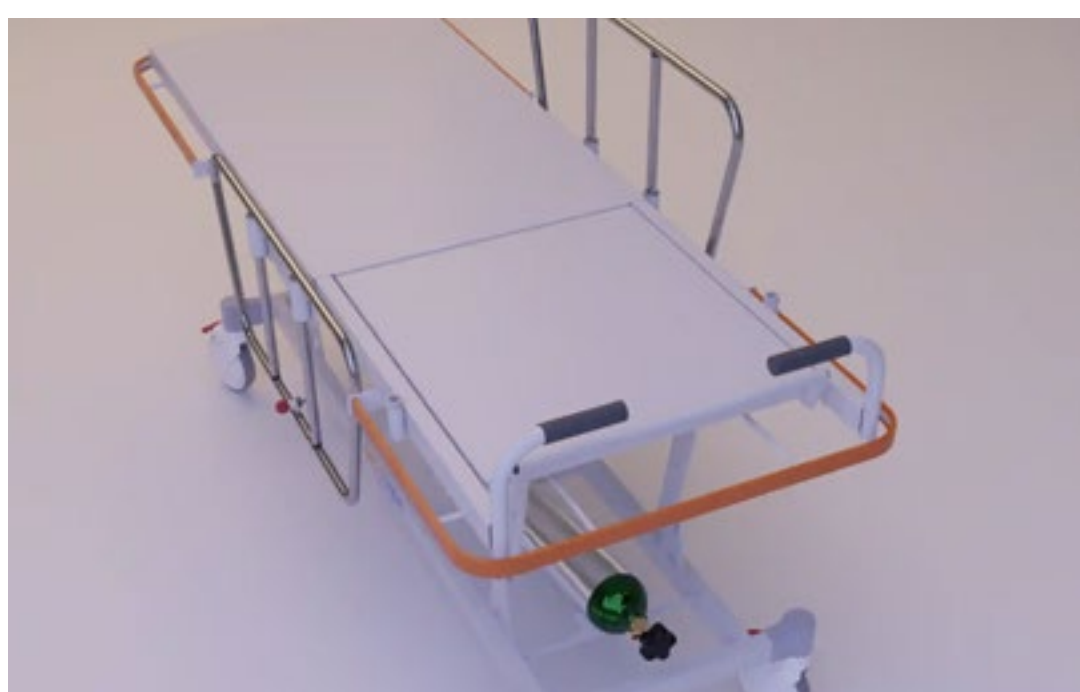

Parachoque de proteção total

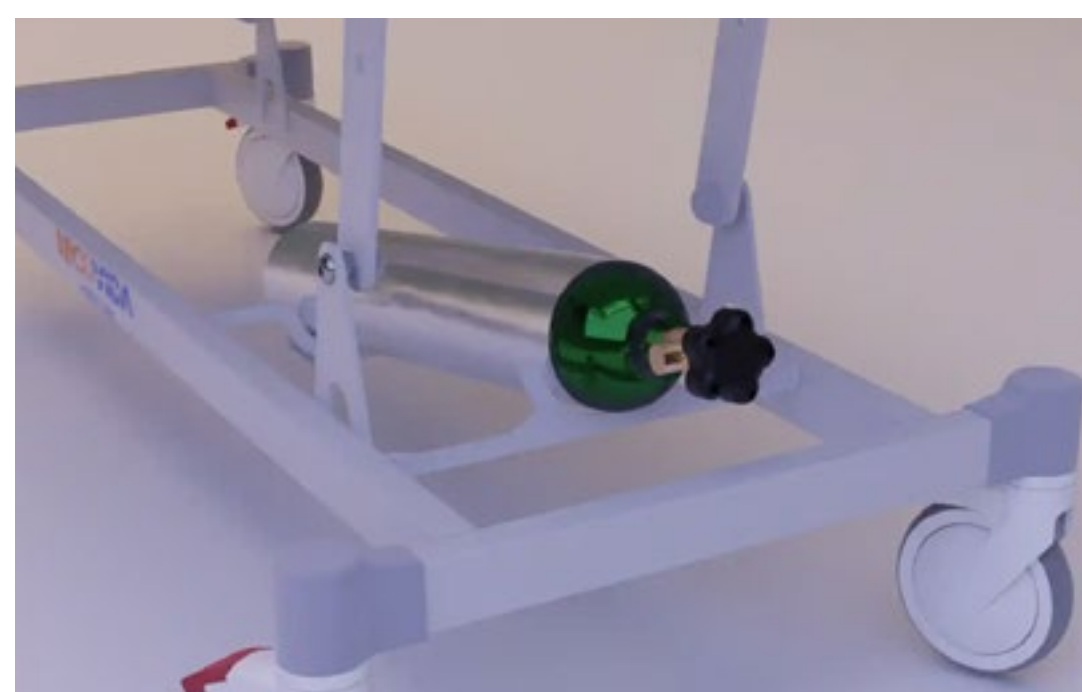

Suporte para Oxigênio

## MOVIMENTOS DO LEITO



Fowler Dorso

0 - 60°



Elevação mínima

500mm



Elevação máxima

800mm



### DADOS TÉCNICOS

Leito: Comp: 1850mm; Largura: 600mm;  
Total: Comp: 2100mm;  
Largura: 650mm; Altura: 500 - 800mm.



Freio individual



Movimentação do Dorso



Grades em aço inox

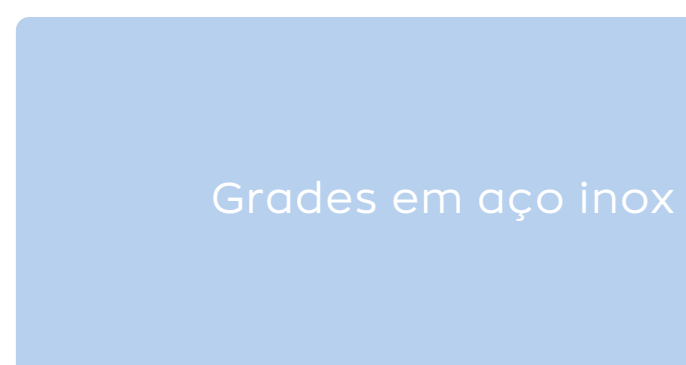

### RECURSOS PADRÕES

- Dorso com sistema de regulagem por cremalheira.
- Rodas de 6”.



Parachoque de proteção total

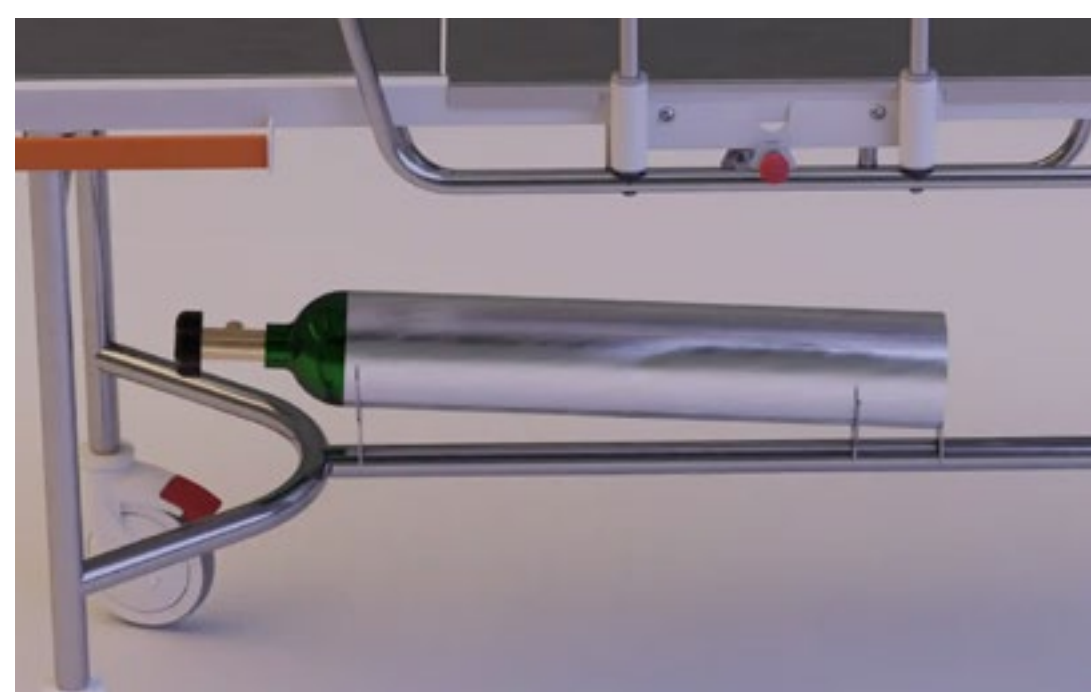

Suporte para Oxigênio

### MOVIMENTOS DO LEITO



Fowler  
Dorso

0 - 60°



### DADOS TÉCNICOS

Leito: Comp: 1850mm; Largura: 600mm;  
Total: Comp: 2100mm;  
Largura: 650mm; Altura: 780mm.



Freio Diagonal

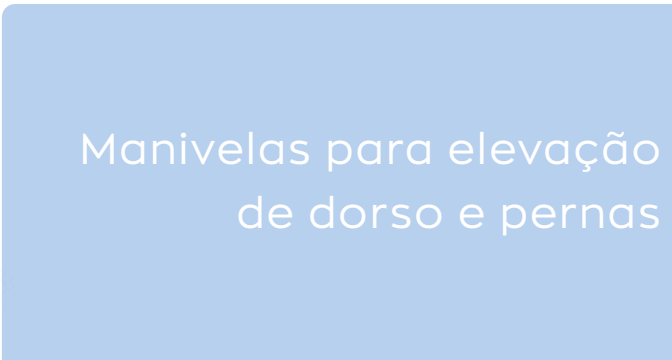

Manivelas para elevação de dorso e pernas

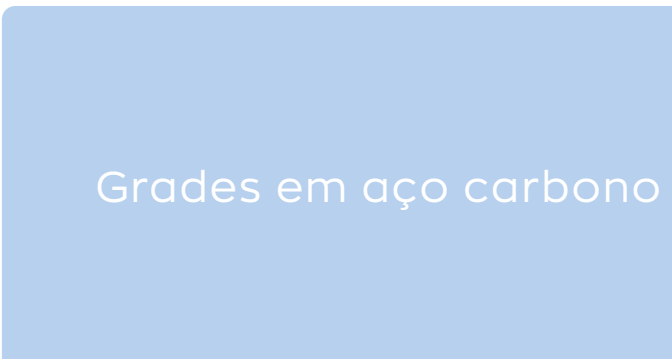

Grades em aço carbono



180Kg



**RECURSOS PADRÕES**

- Grades com regulagens de altura.
- Rodas duplas de 3" com baixo ruído e proteção para pisos.
- Leito dividido em 4 sessões.



Desenhos Lúdicos



Parachoque

**MOVIMENTOS DO LEITO**



Fowler Dorso

0 - 80°



Fowler Pernas

0° - 20°



**DADOS TÉCNICOS**

Leito: Comp: 1500mm; Largura: 700mm;  
Total: Comp: 1700mm;  
Largura: 880mm; Altura: 620mm.



Freio individual

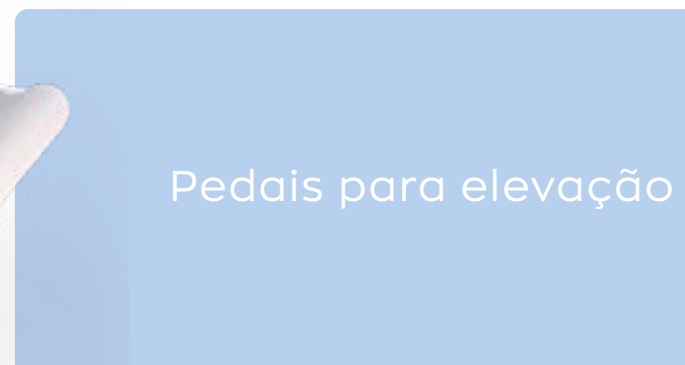

Pedais para elevação



Suporte para Papel descartável

### RECURSOS PADRÕES

- Base em termoplástico.
- Estofamento em courvin de alta resistência.
- Rodas giratórias duplas de 4”.
- Estrutura em aço carbono com

pintura eletrostática.



Suporte p/ cilindro de oxigênio



Elevação à gás

### MOVIMENTOS DO LEITO



Fowler Dorso



Elevação mínima



Elevação máxima

940mm | 650mm



#### DADOS TÉCNICOS

Total: Comp: 1850mm;  
Largura: 600mm; Altura: 940 - 650mm.



### RECURSOS PADRÕES

- Suporte p/ Papel descartável.
- Estrutura de MDF.
- Estovamento em courvin de alta resistência.
- 4 Gavetas com corrediças

telescópicas

- Elevação de dorso.

### MOVIMENTOS DO LEITO



Fowler  
Dorso



#### DADOS TÉCNICOS

Total: Comp: 1800mm;  
Largura: 600mm; Altura: 800mm.





## RECURSOS PADRÕES

- Suporte p/ Papel descartável.
- Estrutura de MDF.
- Estovamento em courvin de alta resistência.
- 4 Gavetas com corrediças

telescópicas

- Elevação de dorso.
- Regulagem para peseira.
- Suporte p/ coxas.

## MOVIMENTOS DO LEITO



Fowler  
Dorso



Fowler  
Pernas



Posição  
Poltrona



Posição  
Litotômica



### DADOS TÉCNICOS

Total: Comp: 1850mm;  
Largura: 600mm; Altura: 800mm.



### RECURSOS PADRÕES

- Estrutura de aço inox.
- Estovamento em courvin de alta resistência.
- Elevação de dorso.

### MOVIMENTOS DO LEITO



Fowler  
Dorso



#### DADOS TÉCNICOS

Total: Comp: 1850mm;  
Largura: 600mm; Altura: 800mm.



## RECURSOS PADRÕES

- Estrutura aço carbono com pintura e tratamento anti ferrugem.
- Protetor de parede no encosto.
- Superfície de Courvin cor sólida.

- Braços revestidos e acolchoados.
- Encosto e peseira articulado em sincronia para o modo relax.

## MOVIMENTOS



Fowler  
Dorso



Fowler  
Pernas



### DADOS TÉCNICOS

Total: Comp: ≈780mm;  
Largura: ≈710mm; Altura: 470mm.



## RECURSOS PADRÕES

- Estofado D-28 e Super Soft D-23.
- 3 assentos.



### DADOS TÉCNICOS

Total: Comp: ≈1950mm;  
Largura: ≈930mm; Altura: ≈450mm.



### RECURSOS PADRÕES

- Tampo em MDF.
- Com regulagem de altura.
- Rodas duplas giratórias.
- Base é em formato de U que se encaixa perfeitamente nas mesas

de cabeceira da Metahospitalar.



#### DADOS TÉCNICOS

Total: Comp: 680mm;

Largura: 360mm; Altura: 930 - 1080mm.



#### RECURSOS PADRÕES

- Estrutura de MDF.
- 1 Gaveta.
- 1 Porta.
- 4 rodas de rodízios duplos.



#### DADOS TÉCNICOS

Total: Comp: 400mm;  
Largura: 430mm; Altura: 765mm.

## Mesas Auxiliares



ND 1900

### DADOS TÉCNICOS

Total: Comp: 400mm;  
Largura: 400mm; Altura: 800mm.



ND 1901

### DADOS TÉCNICOS

Total: Comp: 600mm;  
Largura: 400mm; Altura: 800mm.



ND 1902

### DADOS TÉCNICOS

Total: Comp: 900mm;  
Largura: 450mm; Altura: 900mm.



ND 1903

### DADOS TÉCNICOS

Total: Comp: 1100mm;  
Largura: 450mm; Altura: 800mm.

### RECURSOS PADRÕES

- Rodas giratórias.
- Feitas em Inox.



## RECURSOS PADRÕES

- Estrutura em aço inox.
- Mesa em inox.
- 10 ganchos para Instrumentos em inox.
- 4 Rodas com rodízios duplos.



## DADOS TÉCNICOS

Total: Comp: 1100mm;  
Largura: 500mm; Altura: 1050mm.





### RECURSOS PADRÕES

- Estrutura em aço inox.
- Bandeja inox.
- Balde em inox.
- Suporte para balde retrátil
- Suporte para bandeja retrátil.

- 4 Rodas com rodizios duplos.



### DADOS TÉCNICOS

Total: Comp: 750mm;  
Largura: 500mm; Altura: 820mm.



### RECURSOS PADRÕES

- Estrutura em aço inox.
- Bandeja inox.
- Suporte para bandeja com regulagem de altura.
- 4 Rodas com rodízios duplos.



### DADOS TÉCNICOS

Total: Comp: ≈540mm;  
Largura: ≈400mm; Altura: ≈1200mm.



### RECURSOS PADRÕES

- Haste em aço inox.
- Base em aço carbono com pintura eletrostática.
- Pés emborrachado.
- Regulagem de altura.

- Concha de poliuretano.



### DADOS TÉCNICOS

Total: Comp: ≈300mm;  
Largura: ≈300mm; Altura: ≈800mm.

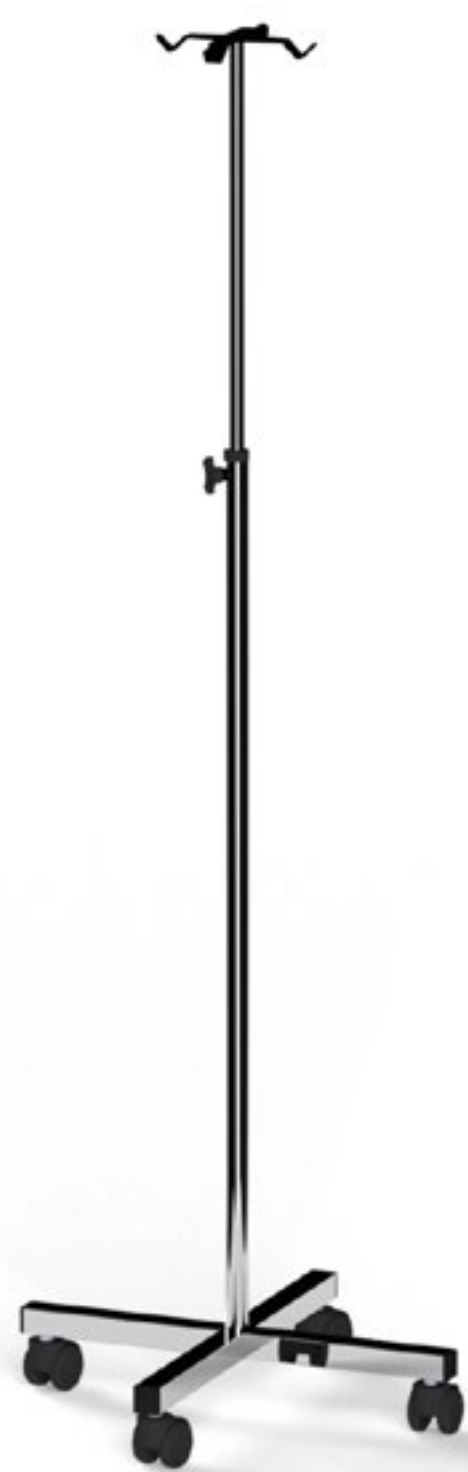

### RECURSOS PADRÕES

- Estrutura em aço inox.
- Base em aço inox.
- 4 rodízios duplos.
- 4 hastes para soro.



#### DADOS TÉCNICOS

Total: Comp: 520mm;  
Altura: 1200 - 2050mm.



ND 1941

**DADOS TÉCNICOS**  
Capacidade 15 litros.



ND 1942

**DADOS TÉCNICOS**  
Capacidade 5 litros.



ND 1943

**DADOS TÉCNICOS**  
Capacidade 12 litros.

## RECURSOS PADRÕES

- Protetor de parede emborrachado.
- 4 rodízios duplos.



## RECURSOS PADRÕES

- Estrutura em aço inox.
- Piso de Alumínio.



### DADOS TÉCNICOS

Total: Comp: 390mm;  
Largura: 380mm; Altura: 380mm.



### RECURSOS PADRÕES

- Banco Giratório.
- Com regulagem de altura.
- Com rodízios duplos em termoplástico.
- Assento estofado.



#### DADOS TÉCNICOS

Total: Comp: ≈370mm;  
Largura: ≈370mm; Altura: 410 - 540mm.



### RECURSOS PADRÕES

- Banco Giratório.
- Com regulagem de altura.
- Com rodízios duplos em termoplástico.
- Assento estofado.

- Encosto com formato anatômico para as costas.



### DADOS TÉCNICOS

Total: Comp: ≈370mm;  
Largura: ≈370mm; Altura: 410 - 540mm.





## RECURSOS PADRÕES

- Estrutura em aço inox.
- 03 rodízios duplos.
- Saco de algodão cru.



**DADOS TÉCNICOS**  
Ø ≈520mm;  
Altura: ≈820mm.



ND - 1652

**ND-1133, ND-1137, ND-1131, ND-1138, ND-1101, ND-1100.**

**DADOS TÉCNICOS**

Total: Comp: 1900mm;  
Largura: 800mm; Altura: 100mm.  
Espuma D-26



ND - 1672

**ND-1150, ND-1151, ND-1142.**

**DADOS TÉCNICOS**

Total: Comp: 1950mm;  
Largura: 830mm; Altura: 100mm.  
Espuma D-28

**RECURSOS PADRÕES**

- Revestimento Courvin.

